

AXIS COMPENSATION MODULES

SERIES ARP

▶ PRODUCT ADVANTAGES

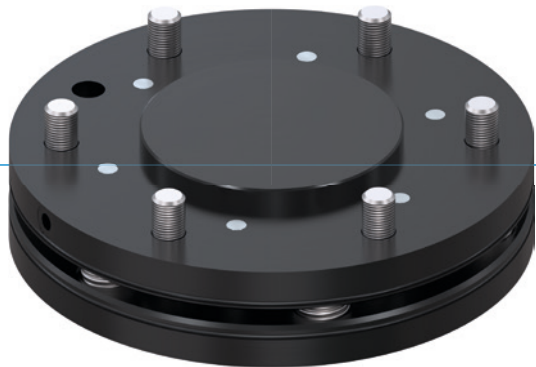

▶ Lockable centre placement

When moving your robot, you can fix the equalizer in place so that uncontrolled movements of the workpiece do not take place

▶ Extremely flat design

This structure reduces the moment load for your robot to a minimum and makes it possible to use smaller and more affordable sizes

▶ Variable balancing force and moment

Adjust the equaliser to your handling weight by mounting a spring package based on desired rigidity

▶ THE BEST PRODUCT FOR YOUR APPLICATION



▶ Our products welcome the challenge!

Extreme conditions, all over the world—our tried and tested components and systems give you endless possibilities.

Find the best product for your specific use:

www.zimmer-group.com

► BENEFITS IN DETAIL

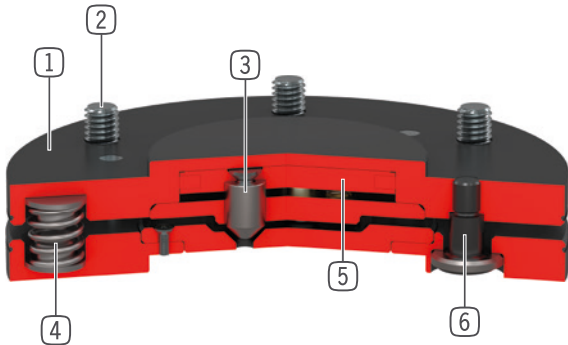

- ① **Robust, lightweight housing**
 - Hard-coated aluminum alloy
- ② **Robot flange**
 - partial mounting circle in accordance with EN ISO 9409-1
- ③ **Locking**
 - 3 locking pistons
 - nitrated steel
- ④ **Spring package**
 - version size 63, stronger one is available
 - version size 100, 3 springs can be removed
- ⑤ **Locking drive**
 - single-acting pneumatic cylinder
- ⑥ **Guiding bolts with ball cup**

► TECHNICAL DATA

Installation size	Connecting flange according EN ISO 9409-1	Deflection horizontal +/-	Deflection vertical +/-
		[mm/°]	[mm/°]
AR40P	TK 40	2 / 1	2 / 1
AR50P	TK 50	2 / 1	2 / 1
AR63P	TK 63	2 / 1	2 / 1
AR80P	TK 80	2 / 1	2 / 1
AR100P	TK 100	2 / 1	2 / 1
AR125P	TK 125	2 / 1	2 / 1
AR160P	TK 160	2 / 1	2 / 1

► FURTHER INFORMATION IS AVAILABLE ONLINE



All information just a click away at: www.zimmer-group.com. Find data, illustrations, 3D models and operating instructions for your installation size using the order number for your desired product. Quick, clear and always up-to-date.

AXIS COMPENSATION MODULES

INSTALLATION SIZE AR50P

▶ PRODUCT SPECIFICATIONS



▶ Variable installation position

Shows the maximum handling weight depending on acceleration and lever arm. Does not replace the technical design.

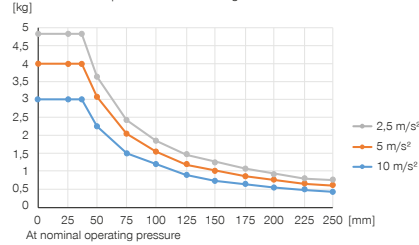

▶ Forces and moments

Shows static forces and moments which may impact on the axis compensation module.

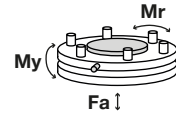

Mr [Nm]	60
My [Nm]	60
Fa [N]	800

▶ Spring Pack 1 (pre-assembled)

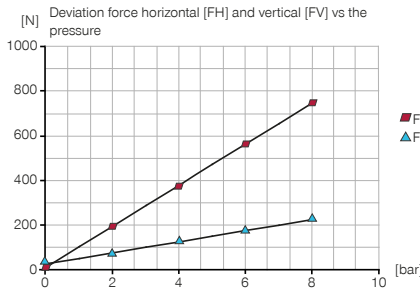

▶ Spring Pack 1 (pre-assembled)

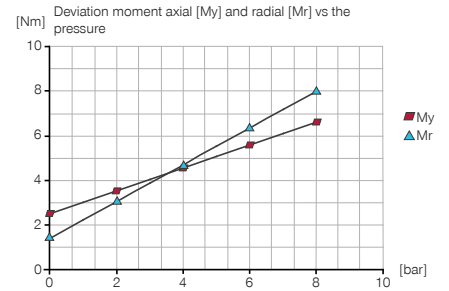

▶ INCLUDED IN DELIVERY



4 [piece]
Cylinder Screw
C7984060129



4 [piece]
Spring Pack 1 (pre-assembled)
CFED11180

▶ RECOMMENDED ACCESSORIES



ENERGY SUPPLY



WVM3
Angled Fittings - Barb Style Connection



ENERGY SUPPLY



GVM3
Straight Fittings - Barb Style Connection

Order no.	Technical data
Connecting flange according EN ISO 9409-1	TK 50
Installation Height [mm]	21.5
Horizontal deviation +/- [mm]	2
Horizontal deviation +/- [°]	1
Vertical deviation +/- [mm]	2
Vertical deviation +/- [°]	1
Centering force when locking [N]	170
Repetition accuracy Horizontal +/- [mm/°]	0.05
Repetition accuracy Vertical +/- [mm/°]	0.05
Air volume per cycle [cm³]	2
Operating pressure [bar]	1 ... 8
Nominal operating pressure [bar]	6
Operating temperature [°C]	5 ... +80
Moment of inertia [kgcm²]	1.1
Weight [kg]	0.2

