

# SELF-CLOSING DEVICE

## SERIES SILENTO CHIUSO 70

### ▶ PRODUCT SPECIFICATIONS

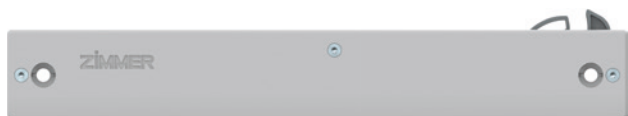

This self-closing device features outward closing, which enables maximum door opening. It is ideally suited for use in the sliding door cabinet. Its compact plastic housing allows it to be discreetly integrated.

### ▶ APPLICATION AREAS

 Door	
 Sliding door	●
 Drawer	
 Hinge	

### ▶ SERIES CHARACTERISTICS

Series	Stroke [mm]	Medium	Operating direction
Silento Chiuso 70	70.0	Fluid	Outward closing

### ▶ TECHNICAL DRAWING

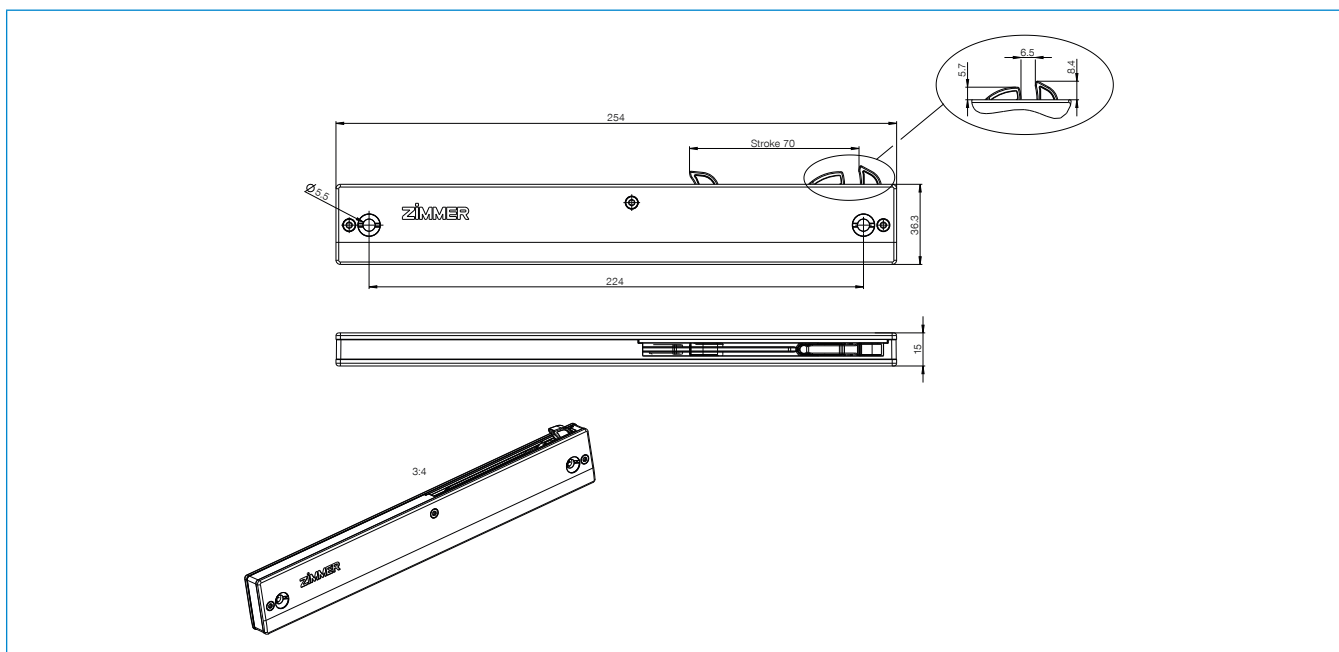

## ► TECHNICAL DATA

Order no.	E070-08-007	E070-08-009	E070-08-010
Mass to be braked [kg]	30.0	50.0	70.0
Operating direction	Outward closing	Outward closing	Outward closing
Free-run	No	No	No
Free-run length [mm]	0.0	0.0	0.0
Technology	Defined Comfort	Defined Comfort	Defined Comfort
Total length max. [mm]	254.0	254.0	254.0
SCU housing color	Gray RAL7035	Gray RAL7035	Gray RAL7035
SCU locking lever color	Natural	Natural	Natural
SCU Ø drilled holes [mm]	5.5	5.5	5.5
SCU width [mm]	15.0	15.0	15.0
SCU height [mm]	36.3	36.3	36.3
SCU locking lever design	Type S	Type S	Type S

# CLOSING UNITS

## SELF-CLOSING DEVICES

### PRINCIPLE OF FUNCTION

A automatic self-closing unit will be assembled at the cabinet for example whereas the activator is assembled at the drawer itself.

The activator will be linked within the hook thus enabling the transfer of the force. The self-closing unit could however also be assembled at the drawer and the activator at the cabinet.

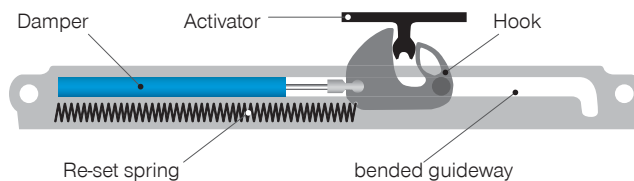

### TYPES



closing inwards



closing outwards



double acting

### CLOSING INWARDS SELF-CLOSING UNITS

At the closed drawer-position the activator is linked within the hook. During opening the hook will be pulled in right direction and the re-set spring will be stretched. The hook will be guided by means of two pins inside the bended guideway.

After a certain opening-movement the hook is fitting in the offset-position, this disconnecting the hook and the activator. The drawer can be opened without any further effort.

At the closing of the drawer, the hook will be activated of the activator. The return spring pulls the drawer in end position while damping.

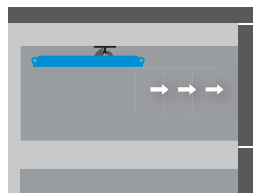
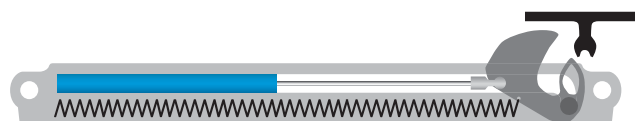
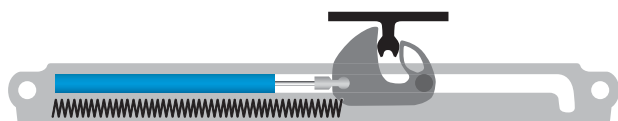

### PRODUCT RANGE SELF-CLOSING (CLOSING INWARDS / DOUBLE ACTING)

- ▶ Housing length (l): 200 bis 385 mm
- ▶ Housing height (b): 18 bis 25 mm
- ▶ Housing depth (t): 10,4 bis 18 mm
- ▶ Stroke (s): 50 bis 100 mm

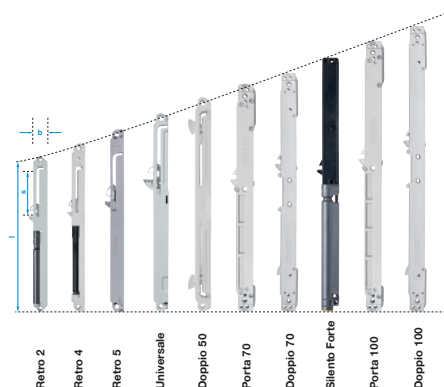

## CLOSING OUTWARDS SELF-CLOSING UNITS

If there might not be sufficient space available for to assemble the activator, an outwards working self-closing unit can be used.

This system has a separate spacer which deflects the force so that the damper works on pressure.

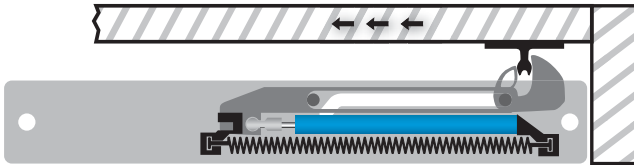

Door closed

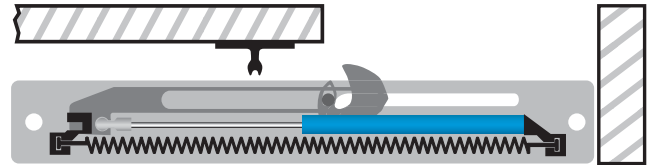

Door open

## ASSEMBLY OF THE SELF-CLOSING UNITS

The above example is showing a wardrobe with two sliding-doors. The activators have to be assembled onto the sliding doors as near to the side-wall as possible in order to prevent collision with the second door resp. the cabinet.

Use an outward closing unit.

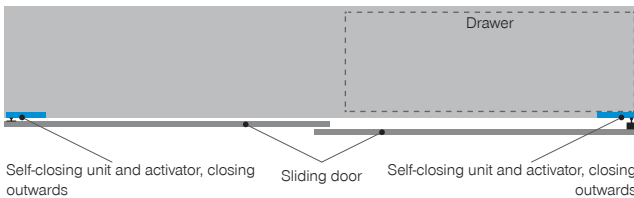

Wardrobe, closed

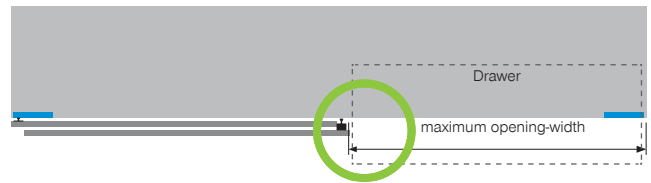

Wardrobe, open

## PRODUCT RANGE SELF-CLOSING (CLOSING INWARDS / DOUBLE ACTING)

Housing length (l): 200 bis 385 mm  
 Housing bright (b): 18 bis 25 mm  
 Housing depth (t): 10,4 bis 18 mm  
 Stroke (s): 50 bis 100 mm

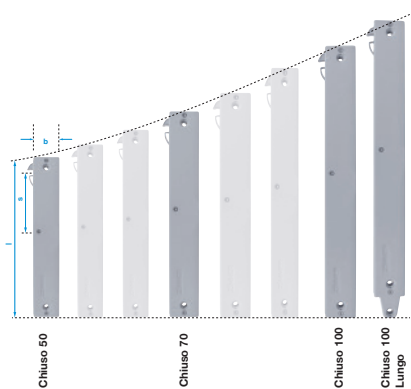

## DOUBLE ACTING SELF-CLOSING UNITS

In order to dampen sliding doors within both directions double acting self closing units will be used.

The activator will be assembled at the cabinet; the self closing units on top of the sliding door.



Sliding-door, damping to the right side

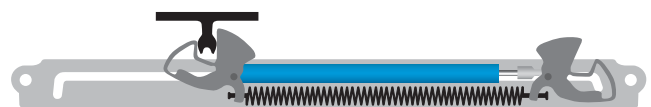

Sliding-door, damping to the left side