

2指张角式抓手

GG1000 系列

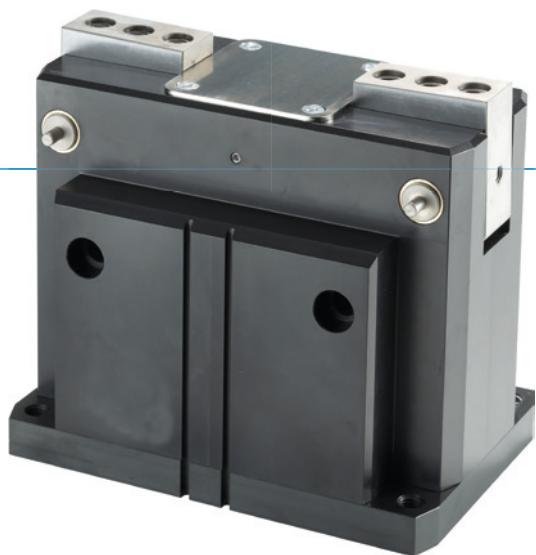





▶ 产品优点



"强大的"

- ▶ **高抓取力**
高抓取力,您可以安全的抓取最重的工件
- ▶ **高力矩负载**
使用大尺寸角度齿轮箱确保应用的高耐用性
- ▶ **无间断的持续工作**
“德国制造”象征着我们决不妥协的质量要求,保证免维护运行一千万次循环

▶ 产品特点

尺寸型号	版本	
	NC	FNC
GG1XXX		
 可侧向固定抓手手指		●
 弹簧式自锁/常闭	●	●
 (最多)1千万次循环免维护	●	●
 接近传感器	●	●
 磁场传感器	●	●
 阻隔空气密封	●	●
 IP 40	●	●



优势细节

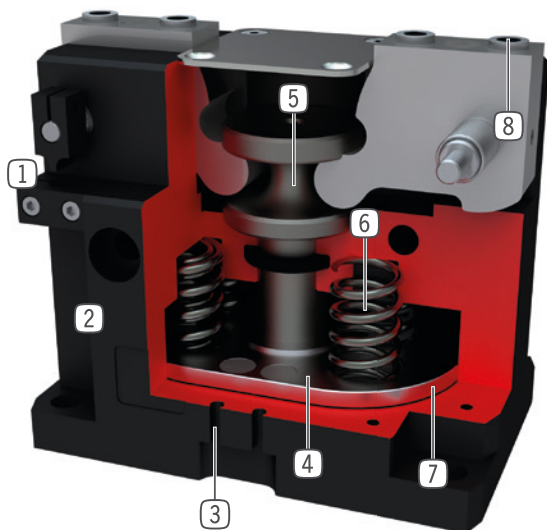

- ① 检测块和安装块
- 用于位置检测
- ② 坚固且轻的外壳
- 硬涂层铝合金
- ③ 检测槽
- 用于放置安装磁性传感器
- ④ 永久磁铁
- 通过磁性传感器检测活塞位置
- ⑤ 主动驱动的杠杆原理
- 抓手手指同步移动
- ⑥ 内置保持力安全装置
- 气缸内置弹簧作为能量储存
- ⑦ 驱动
- 双作用气缸
- ⑧ 可拆卸中心定位环
- 快速便捷的手指安装

技术数据

尺寸型号	行程 [°]	夹持力 [N]	重量 [kg]	IP 等级
GG1065	20	2910 - 4160	1,3 - 1,4	IP40
GG1085	20	7120 - 9670	2,8 - 3,2	IP40
GG1110	20	18665 - 23240	6,3 - 6,7	IP40
GG1140	20	29110 - 36470	12,4 - 13	IP40

更多详情请上网查询



所有信息查询请点击：www.zimmer-group.com。产品参数、绘图、3D模型和操作说明均可根据产品型号查询。清晰且实时更新。

2指张角式抓手

GG1140 尺寸型号

产品规格



夹持力图表

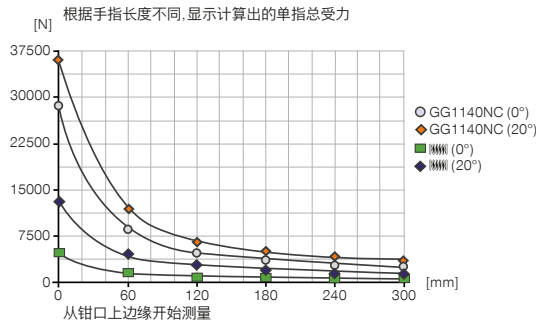

力和力矩

显示除夹持力外可能作用的静力和力矩。

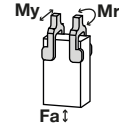

Mr [Nm]	110
My [Nm]	120
Fa [N]	1500

随货提供



4 [片]
中心定位环
DST42000

配件建议



能源供应



GV1-4X8
直插接头-快接式



传感器



MFS01-S-KHC-P2-PNP
2点传感器盖, 电缆0.3 m-插头M8



传感器



MFS02-S-KHC-P2-PNP
2点传感器直头, 电缆0.3 m-连接器M8



KB8-43
接近开关安装座



接口 / 其他



KHA1140-8
备选接近开关支架



HES0008
行程调节螺丝



NJ8-E2S
接近开关 - M8连接头



KAG500
插入式直连接头电缆 5 m - M8插头(母头)



MFS01-S-KHC-P1-PNP
倾斜的磁场传感器, 电缆0.3 m-插头M8



KAW500
插入式弯角连接头电缆 5 m - M8插头(母头)



MFS02-S-KHC-P1-PNP
磁场传感器直的, 电缆0.3m-插头M8



► 技术数据

订购编号	GG1140NC	GG1140FNC
单边行程 [°]	20	20
最大闭合抓取力矩 [Nm]	725	725
弹簧确保的最小力矩 [Nm]	143	143
抓斗关闭时的抓取力为0° [N]	29110	29110
抓手关闭时最大夹持力 (20°) [N]	36470	36470
由弹簧确保夹持力 (0°) [N]	5740	5740
由弹簧确保夹持力 (20°) [N]	13110	13110
闭合时间 [s]	0.25	0.25
张开时间 [s]	0.5	0.5
重复定位精度 +/- [mm]	0.05	0.05
最小操作气压 [bar]	4	4
最大操作气压 [bar]	8	8
额定操作气压 [bar]	6	6
最低操作温度 [°C]	5	5
最高操作温度 [°C]	+80	+80
每循环耗气体积 [cm³]	760	760
根据IEC 60529标准安全保护	IP40	IP40
重量 [kg]	12.4	13

