

# 2-JAW RADIAL GRIPPER

## SERIES GG4000

### ▶ PRODUCT ADVANTAGES

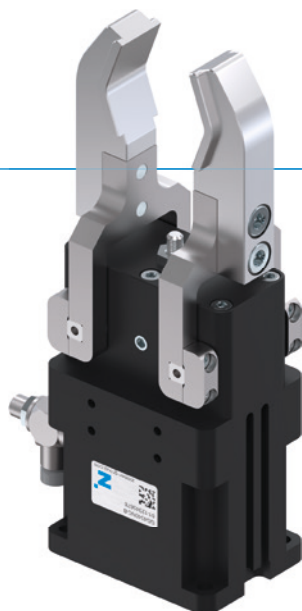

#### “The sealed”

##### ▶ Suitable for use under extreme conditions

The sealed rotation axis guarantees process reliability even under the harshest conditions









##### ▶ Smooth stroke configuration

You can adjust the 180° opening angle to be unique to your application using an adjusting screw

##### ▶ Failure-free continuous operation

Our uncompromising “Made in Germany” quality guarantees up to 10 million maintenance-free cycles

### ▶ SERIES CHARACTERISTICS

Installation size	Version	
GG40XX-B	NC	SC
 Spring closing C	•	•
 High-strength S		•
 10 million maintenance-free cycles (max.)	•	•
 Inductive sensor	•	•
 Magnetic field sensor	•	•
 Protected against corrosion	•	•
 Purged air	•	•
 IP 64	•	•



## ► BENEFITS IN DETAIL

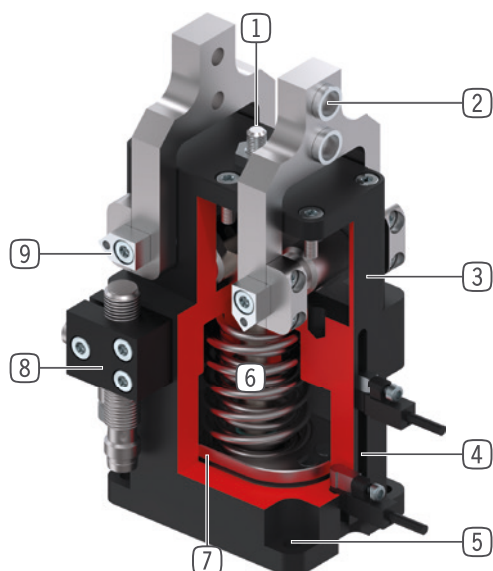

- ① **Stroke adjustment screw**
  - Infinitely adjustable opening stroke
- ② **Removable centering sleeves**
  - individual gripper finger mounting
- ③ **Robust, lightweight housing**
  - Hard-coated aluminum alloy
- ④ **Sensing slot**
  - mounting and positioning of magnetic field sensors
- ⑤ **Mounting and positioning**
  - mounting possible from several sides for versatile positioning
- ⑥ **Integrated gripping force safety device**
  - spring integrated into cylinder as energy storage
- ⑦ **Position sensing**
  - permanent magnet for direct monitoring of piston movement
- ⑧ **Mounting block**
  - mounting for inductive proximity switch
- ⑨ **Sealed rotation point**
  - for use under extreme conditions

## ► TECHNICAL DATA

Installation size	Stroke per jaw (+/-)	Gripping force	Weight	IP class
	[°]	[N]	[kg]	
GG4032	20 - 90	430 - 460	0,25	IP64
GG4040	20 - 90	700 - 800	0,5	IP64
GG4049	20 - 90	1000 - 1150	0,85	IP64
GG4058	20 - 90	1650 - 1900	1,4	IP64
GG4072	20 - 90	1950 - 2700	2,45	IP64
GG4084	20 - 90	3500 - 4000	4,5	IP64

## ► FURTHER INFORMATION IS AVAILABLE ONLINE



All information just a click away at: [www.zimmer-group.com](http://www.zimmer-group.com). Find data, illustrations, 3D models and operating instructions for your installation size using the order number for your desired product. Quick, clear and always up-to-date.

# 2-JAW RADIAL GRIPPER

## INSTALLATION SIZE GG4040

### ▶ PRODUCT SPECIFICATIONS



#### ▶ Gripping force diagram

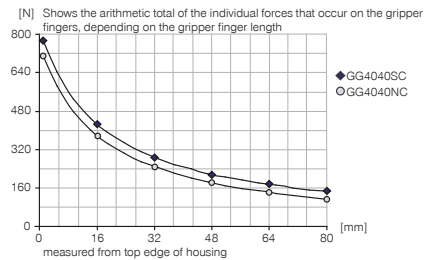

#### ▶ Forces and moments

Displays static forces and moments that can also have an effect, besides the gripping force.

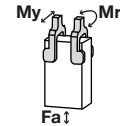

Mr [Nm]	19
My [Nm]	19
Fa [N]	180

#### ▶ Moment of inertia

GG4040NC-B

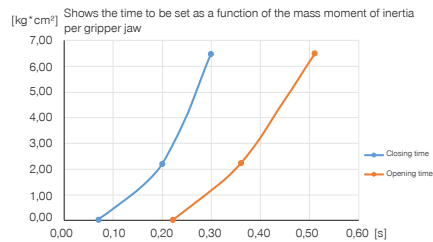

#### ▶ Moment of inertia

GG4040SC-B

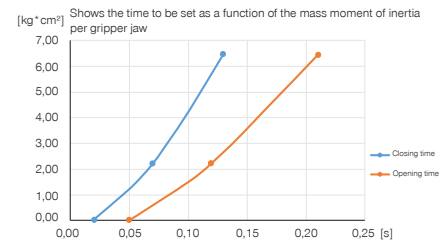

### ▶ INCLUDED IN DELIVERY



4 [piece]  
Centering Disc  
DST40800



2 [piece]  
Flow Control Valves - with Swivel joint  
DRVM5X4

### ▶ RECOMMENDED ACCESSORIES



#### ENERGY SUPPLY



**DSV1-8E**  
Pressure safety valve with quick exhaust



#### SENSORS



**MFS02-S-KHC-P1-PNP**  
Magnetic field sensor straight, cable 0.3 m - M8 connector



#### SENSORS



**KB8-48**  
Mounting block



**MFS01-S-KHC-P2-PNP**  
2-point sensor angled, cable 0.3 m - M8 connector



**MFS02-S-KHC-P2-PNP**  
2-point sensor straight, cable 0.3 m - M8 connector



**NJ8-E2S**  
Inductive proximity switch - Connector M8



**MFS02-S-KHC-IL**  
Position sensor straight, cable 0.3 m - connector M8



**MFS01-S-KHC-P1-PNP**  
Magnetic field sensor angled, cable 0.3 m - M8 connector



Order no.	► Technical data	
	GG4040NC-B	GG4040SC-B
Stroke per jaw [°]	90	20
Gripping moment in closing at 0° [Nm]	13	15
Gripping moment secured by spring min. [Nm]	3.2	5.2
Gripping force in closing at 0° [N]	700	800
Dead weight of mounted gripper finger max. [kg]	0.12	0.12
Length of the gripper fingers max. [mm]	85	85
Closing time [s]	0.06	0.02
Opening time [s]	0.11	0.06
Repetition accuracy +/- [mm]	0.05	0.05
Operating pressure min. [bar]	4	4
Operating pressure max. [bar]	8	8
Nominal operating pressure [bar]	6	6
Operating temperature min. [°C]	5	5
Operating temperature max. [°C]	+80	+80
Air volume per cycle [cm <sup>3</sup> ]	24	18
Protection to IEC 60529	IP64	IP64
Weight [kg]	0.53	0.53

