

2-JAW RADIAL GRIPPER

SERIES GG4000

▶ PRODUCT ADVANTAGES

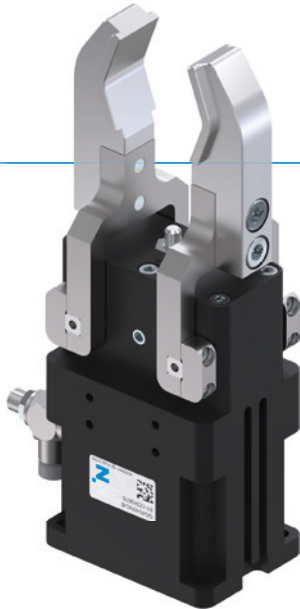

“The sealed”

▶ Suitable for use under extreme conditions

The sealed rotation axis guarantees process reliability even under the harshest conditions









▶ Smooth stroke configuration

You can adjust the 180° opening angle to be unique to your application using an adjusting screw

▶ Failure-free continuous operation

Our uncompromising “Made in Germany” quality guarantees up to 10 million maintenance-free cycles

▶ SERIES CHARACTERISTICS

Installation size	Version	
GG40XX-B	NC	SC
 Spring closing C	•	•
 High-strength S		•
 10 million maintenance-free cycles (max.)	•	•
 Inductive sensor	•	•
 Magnetic field sensor	•	•
 Protected against corrosion	•	•
 Purged air	•	•
 IP 64	•	•



► BENEFITS IN DETAIL

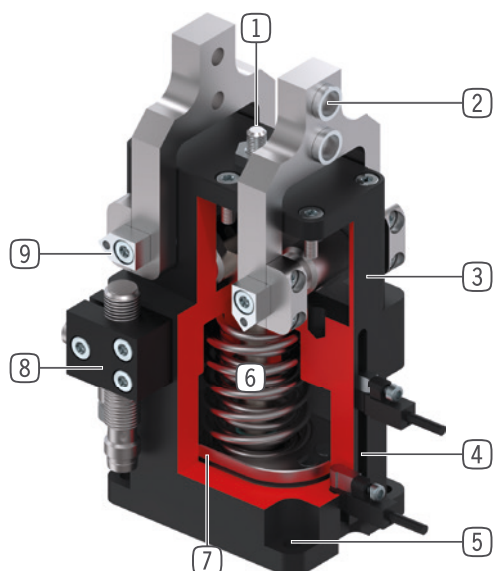

- ① **Stroke adjustment screw**
 - Infinitely adjustable opening stroke
- ② **Removable centering sleeves**
 - individual gripper finger mounting
- ③ **Robust, lightweight housing**
 - Hard-coated aluminum alloy
- ④ **Sensing slot**
 - mounting and positioning of magnetic field sensors
- ⑤ **Mounting and positioning**
 - mounting possible from several sides for versatile positioning
- ⑥ **Integrated gripping force safety device**
 - spring integrated into cylinder as energy storage
- ⑦ **Position sensing**
 - permanent magnet for direct monitoring of piston movement
- ⑧ **Mounting block**
 - mounting for inductive proximity switch
- ⑨ **Sealed rotation point**
 - for use under extreme conditions

► TECHNICAL DATA

Installation size	Stroke per jaw (+/-)	Gripping force	Weight	IP class
	[°]	[N]	[kg]	
GG4032	20 - 90	430 - 460	0,25	IP64
GG4040	20 - 90	700 - 800	0,5	IP64
GG4049	20 - 90	1000 - 1150	0,85	IP64
GG4058	20 - 90	1650 - 1900	1,4	IP64
GG4072	20 - 90	1950 - 2700	2,45	IP64
GG4084	20 - 90	3500 - 4000	4,5	IP64

► FURTHER INFORMATION IS AVAILABLE ONLINE



All information just a click away at: www.zimmer-group.com. Find data, illustrations, 3D models and operating instructions for your installation size using the order number for your desired product. Quick, clear and always up-to-date.

2-JAW RADIAL GRIPPER

INSTALLATION SIZE GG4049

▶ PRODUCT SPECIFICATIONS



▶ Gripping force diagram

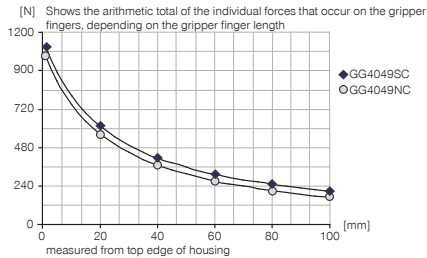

▶ Forces and moments

Displays static forces and moments that can also have an effect, besides the gripping force.

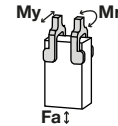

Mr [Nm]	22
My [Nm]	22
Fa [N]	475

▶ Moment of inertia

GG4049NC-B

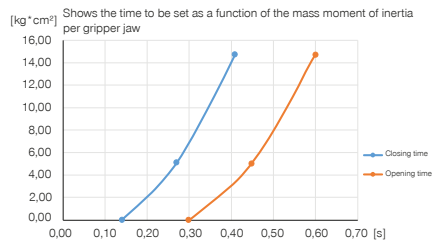

▶ Moment of inertia

GG4049SC-B

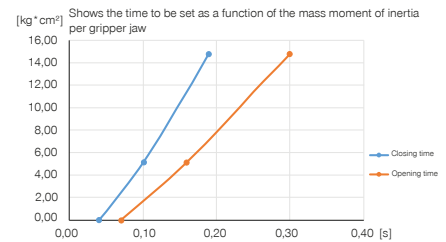

▶ INCLUDED IN DELIVERY



4 [piece]
Centering Disc
DST41000



2 [piece]
Flow Control Valves - with Swivel joint
DRVM5X4

▶ RECOMMENDED ACCESSORIES



ENERGY SUPPLY



DSV1-8E
Pressure safety valve with quick exhaust



SENSORS



MFS02-S-KHC-P1-PNP
Magnetic field sensor straight, cable 0.3 m - M8 connector



SENSORS



KB8-49
Mounting block



MFS01-S-KHC-P2-PNP
2-point sensor angled, cable 0.3 m - M8 connector



MFS02-S-KHC-P2-PNP
2-point sensor straight, cable 0.3 m - M8 connector



NJ8-E2S
Inductive proximity switch - Connector M8



MFS02-S-KHC-IL
Position sensor straight, cable 0.3 m - connector M8



MFS01-S-KHC-P1-PNP
Magnetic field sensor angled, cable 0.3 m - M8 connector



Order no.	► Technical data	
	GG4049NC-B	GG4049SC-B
Stroke per jaw [°]	90	20
Gripping moment in closing at 0° [Nm]	23	26
Gripping moment secured by spring min. [Nm]	4.2	7
Gripping force in closing at 0° [N]	1000	1150
Dead weight of mounted gripper finger max. [kg]	0.2	0.2
Length of the gripper fingers max. [mm]	100	100
Closing time [s]	0.11	0.05
Opening time [s]	0.17	0.09
Repetition accuracy +/- [mm]	0.05	0.05
Operating pressure min. [bar]	4	4
Operating pressure max. [bar]	8	8
Nominal operating pressure [bar]	6	6
Operating temperature min. [°C]	5	5
Operating temperature max. [°C]	+80	+80
Air volume per cycle [cm ³]	44	33
Protection to IEC 60529	IP64	IP64
Weight [kg]	0.88	0.87

