

# BALL JOINTS

## SERIES KG

### ▶ PRODUCT ADVANTAGES



#### ▶ Lockable displacement position

Be flexible in your application, customise the handling to your workpiece and lock the displacement position with process reliability

#### ▶ Large locating flange

The large mounting surface simplifies your design and allows secure attachment of add-on components

#### ▶ Steel design

The highest force and torque measurement enables flexible for maximum dynamics

### ▶ THE BEST PRODUCT FOR YOUR APPLICATION



#### ▶ Our products welcome the challenge!

Extreme conditions, all over the world—our tried and tested components and systems give you endless possibilities.

Find the best product for your specific use:

[www.zimmer-group.com](http://www.zimmer-group.com)



## ▶ PRODUCT SPECIFICATIONS



### ▶ Forces and moments

Shows static forces and torques which may impact on the ball joint

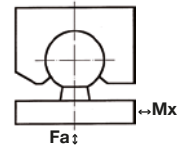

### ▶ Technical data

Order no.	KG40	KG40ST	KG60	KG60ST	KG80	KG80ST
Swivel angle [°]	30	30	30	30	30	30
Mx [Nm]	18	18	55	55	124	124
Fa [N]	7500	18000	15000	45000	28000	70000
Weight [kg]	0.098	0.27	0.33	0.91	0.8	2.2

KG40  
KG40ST

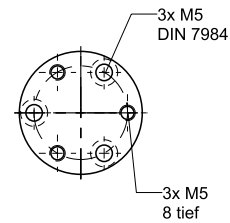
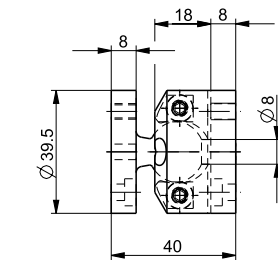
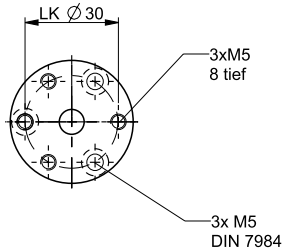

KG60  
KG60ST

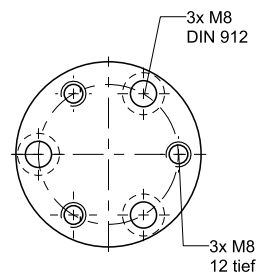
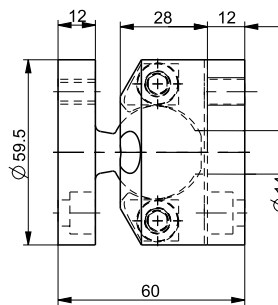
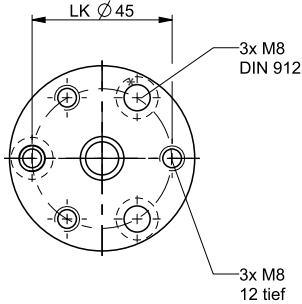

KG80  
KG80ST

