

CLAMPING ELEMENT | PNEUMATIC

LBPS2012IS2-A

▶ PRODUCT ADVANTAGES



- ▶ **broad range of products**
For all common profile rail guides
- ▶ **Safety element, energize to open (NC)**
Safe braking in case of energy failure, through spring-loaded energy storage
- ▶ **high durability**
5 million static clamping cycles
- ▶ **Small and narrow design**
By using U-form piston
- ▶ **Maximum flexibility**
Additional air connection from above
- ▶ **Simple status sensing**
Querying the piston position with magnetic field sensor

▶ TECHNICAL DETAILS



- ① **Profile rail guide**
 - Available for all common profile rail guides
- ② **Wedge-type gear**
 - Power transmission between the pistons and clamping jaws and brake shoes
- ③ **Clamping jaws and brake shoes**
 - Pressed at the free surfaces of the profile rail guide
- ④ **Narrow housing**
- ⑤ **Pneumatic piston**
 - The piston moves the wedge-type gear longitudinally
- ⑥ **Spring-loaded energy storage**
 - For non-pressurized closing of the clamping unit

▶ INFORMATION ON THE PRODUCTS

APPLICATION SCENARIOS

- ▶ **Clamping in case of pressure drop**
- ▶ **Braking linear motors**
- ▶ **Clamping without energy requirement**

FURTHER INFORMATION

- ▶ **Spacer plate**
In addition, a spacer plate might have to be ordered as height compensation, depending on the height of the rail carriage (dimension D).
- ▶ **Special variants on request, e.g.**
With low opening pressure (3.0 bar)

► TECHNICAL DRAWINGS

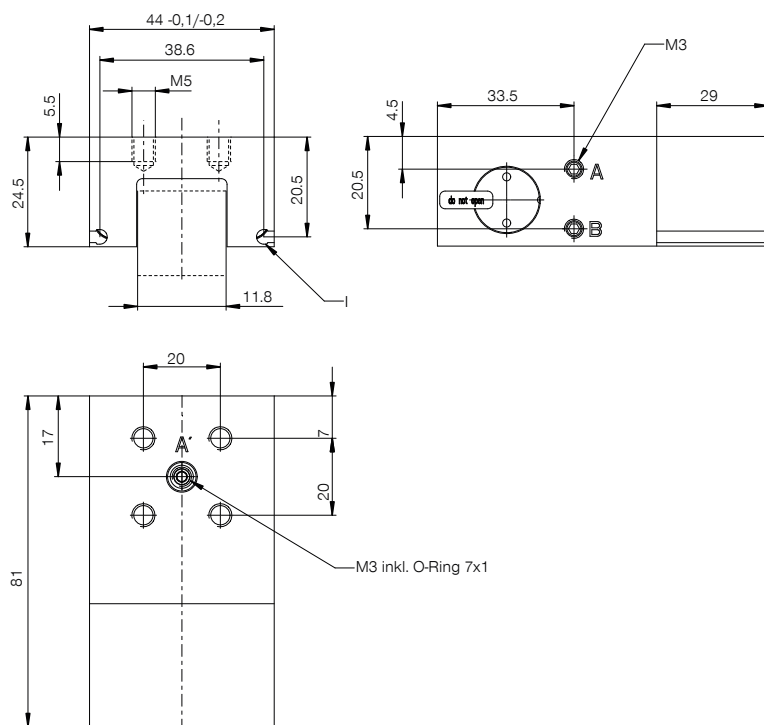

- Ⓐ Connection opening (both sides possible, only one connection necessary)
- Ⓑ Vent filter (one-sided)
- Ⓜ Sensing slot for magentic field sensor (both sides)



► TECHNICAL DATA

Order no.	LBPS2012IS2-A
Operation	pneumatic
Holding force [N]	650
Theoretical holding force ($\mu=0,1$) [N]	813
PLUS connection possible	No
Operating pressure [bar]	5.5 ... 6.5
B10d value	5,000,000
Positioning accuracy +/- [mm]	0,05
Opening time [s]	0.045
Closing time [s]	0.015
Operating temperature [°C]	-10 ... +70
Weight [kg]	0.32
Function	Clamping and braking
Condition	NC (Normally Closed) closed without pressure
Installation direction	from the front
Air volume per cycle [cm ³]	4
Sensor linkage	Sensing slot (both sides)
Connection type	Mirroring at the top
Certifications	CE / UKCA / LABS / REACH / RoHS

Schematic drawing. General tolerances according to DIN ISO 2768 T1-4/T2-H. Edges according to ISO 13715. Element has no guiding properties. Guidance must be external. The holding force is the maximum force that can be applied in the axial direction. Each clamping and braking element is tested in a 100% inspection before delivery for the specified holding forces on a hardened steel rail with a lightly oiled lubricating layer (ISO-VG 68). The use of other lubricants or rail coatings can influence the coefficient of friction. The operating instructions must be observed before commissioning. We reserve the right to make technical changes in the course of further development. The latest and further data can be found online and in the operating instructions at www.zimmer-group.com.