

CLAMPING ELEMENT | PNEUMATIC

MCPS1501H

▶ PRODUCT ADVANTAGES



- ▶ **small construction**
For all common miniature profile rail guides
- ▶ **Energize to open (NC)**
through spring-loaded energy storage
- ▶ **high durability**
5 million static clamping cycles
- ▶ **Higher holding force**
Via activation with PLUS air
- ▶ **Safety element**
Safe clamping in case of energy failure

▶ TECHNICAL DETAILS



- ① **Miniature profile rail guide**
 - Available for all common miniature profile rail guides
- ② **Wedge-type gear**
 - Power transmission between piston and clamping jaw
- ③ **Clamping jaw**
 - Pressed at the free surfaces of the profile rail guide
- ④ **Housing**
- ⑤ **Pneumatic piston**
 - The piston moves the wedge-type gear longitudinally
- ⑥ **Spring-loaded energy storage**
 - For non-pressurized closing of the clamping unit
- ⑦ **Sliding block**
 - For floating bearings

▶ INFORMATION ON THE PRODUCTS

APPLICATION SCENARIOS

- ▶ **Clamping in case of pressure drop**
- ▶ **Clamping without energy requirement**

FURTHER INFORMATION

- ▶ **Special variants on request, e.g.**
 - With low opening pressure (3.0 bar)
 - With additional air connection (from above, from the front)
 - made of stainless steel

► TECHNICAL DRAWINGS

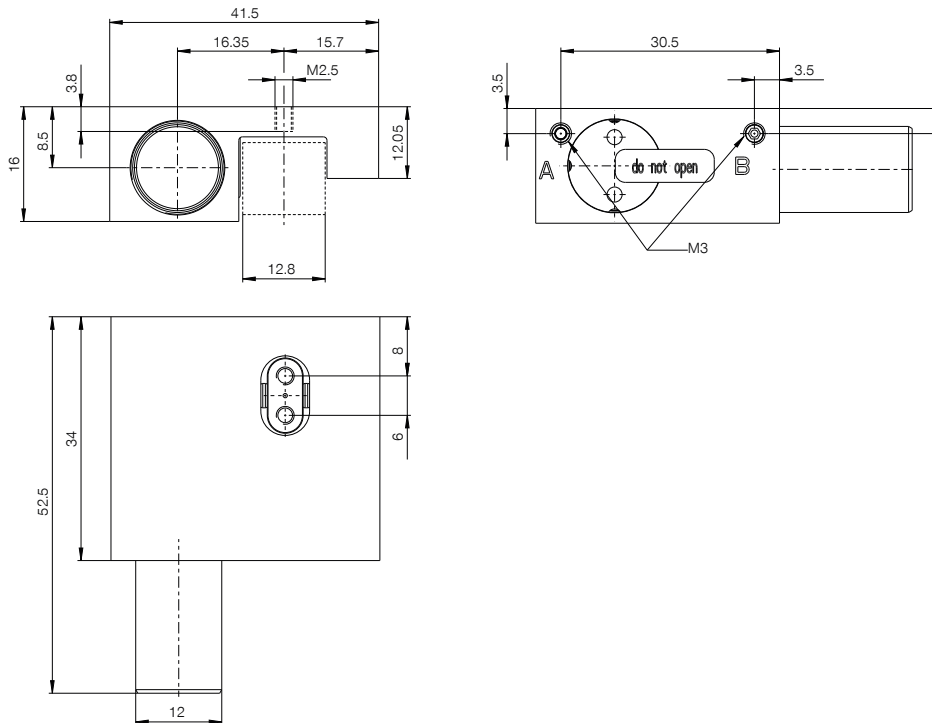

Ⓐ Connection opening

Ⓑ Vent filter



► TECHNICAL DATA

Order no.	MCPS1501H
Operation	pneumatic
Holding force [N]	280
Theoretical holding force ($\mu=0,1$) [N]	350
PLUS connection possible	Yes
Holding force PLUS connection [N]	360
Operating pressure [bar]	5.5 ... 6.5
Nominal operating pressure [bar]	6
B10d value	5,000,000
Positioning accuracy +/- [mm]	0,05
Opening time [s]	0.01
Closing time [s]	0.015
Operating temperature [°C]	-10 ... +70
Weight [kg]	0.11
Function	Clamping
Condition	NC (Normally Closed) closed without pressure
Installation direction	from above
Air volume per cycle [cm ³]	2
Certifications	CE / UKCA / LABS / REACH / RoHS

Schematic drawing. General tolerances according to DIN ISO 2768 T1-4/T2-H. Edges according to ISO 13715. Element has no guiding properties. Guidance must be external. The holding force is the maximum force that can be applied in the axial direction. Each clamping and braking element is tested in a 100% inspection before delivery for the specified holding forces on a hardened steel rail with a lightly oiled lubricating layer (ISO-VG 68). The use of other lubricants or rail coatings can influence the coefficient of friction. The operating instructions must be observed before commissioning. We reserve the right to make technical changes in the course of further development. The latest and further data can be found online and in the operating instructions at www.zimmer-group.com.