

旋翼式气缸

PRN 系列

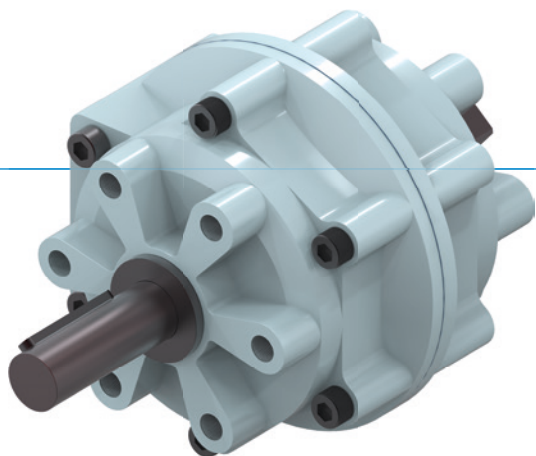





▶ 产品优点



"经济型"

- ▶ **专注于重点**
最经济适用的摆缸降低您的生产成本
- ▶ **终端位置缓冲**
摆到最终位置时用液压缓冲, 这样使您的生产更稳定, 使用寿命更长。
- ▶ **仿传动轴结构**
该轴不仅坚固, 也可以单独调整

▶ 产品特点

尺寸型号	版本				
PRNXXX	-90	-100	-180	-270	-280
 (最多)一百五十万次循环免维护	●	●	●	●	●
 IP54	●	●	●	●	●
 接近传感器	●	●	●	●	●
 可定位 2 个位置	●	●	●	●	●
 90° 旋转角度	●				
 180° 旋转角度			●		
 270° 旋转角度				●	



▶ 初始角度

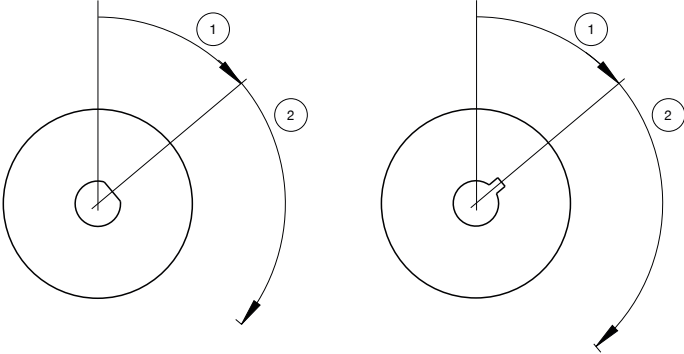

① 初始角度
② 摆动角度



尺寸型号	
PRN1	PRN20
PRN3	PRN30
PRN10	PRN50
	PRN150
	PRN300
	PRN800

▶ 技术数据

尺寸型号	摆动角度 [°]	扭矩 [Nm]	重量 [kg]	IP 等级
PRN1	90 - 270	0,15	0,04	IP54
PRN3	90 - 270	0,38	0,07	IP54
PRN10	90 - 270	1,2	0,14	IP54
PRN20	90 - 270	2,1	0,25	IP54
PRN30	90 - 270	4,1	0,5	IP54
PRN50	90 - 270	5,9 - 12,8	0,75 - 0,8	IP54
PRN150	90 - 270	18 - 41,5	1,6 - 1,9	IP54
PRN300	90 - 270	34,5 - 83	3,6 - 4,1	IP54
PRN800	90 - 270	123 - 247	12 - 13	IP54

▶ 更多详情请上网查询



所有信息查询请点击:www.zimmer-group.com。产品参数、绘图、3D模型和操作说明均可根据产品型号查询。清晰且实时更新。

旋翼式气缸

PRN30 尺寸型号

产品规格



转动惯量

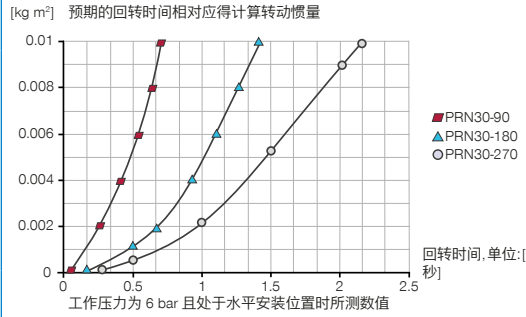

力和力矩

最大静态轴负荷。

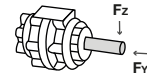

FY [N]	30
FZ [N]	400

配件建议



能源供应



GV1-8X8
直插接头-快接式



DRV1-8X6
流量控制阀 - 转动式



DSV1-8
气压安全阀



DSV1-8E
带快速排气装置的压力安全阀



接口 / 其他



F30-P
法兰



F30-LB
角度法兰



DB30
转动限制器

建议转动限制器配件



AI-M8X1-38
停止位置调节螺丝



NJ12-E2S
接近开关 - M8连接头



NJ12-E2
接近开关电缆5m-直接出线



KAW500
插入式弯角连接头电缆 5 m - M8插头(母头)

订购编号	▶ 技术数据		
	PRN30-90	PRN30-180	PRN30-270
摆动角度 [°]	90	180	270
旋转角度公差 [°]	0° / +3°	0° / +3°	0° / +3°
初始角度 [°]	45	45	45
扭矩 [Nm]	4.1	4.1	4.1
摆动时间 [s]	0.17	0.33	0.5
最小操作气压 [bar]	2	2	2
最大操作气压 [bar]	10	10	10
额定操作气压 [bar]	6	6	6
最低操作温度 [°C]	5	5	5
最高操作温度 [°C]	+60	+60	+60
每循环耗气体积 [cm ³]	74	74	86
根据IEC 60529标准安全保护	IP54	IP54	IP54
重量 [kg]	0.51	0.51	0.51

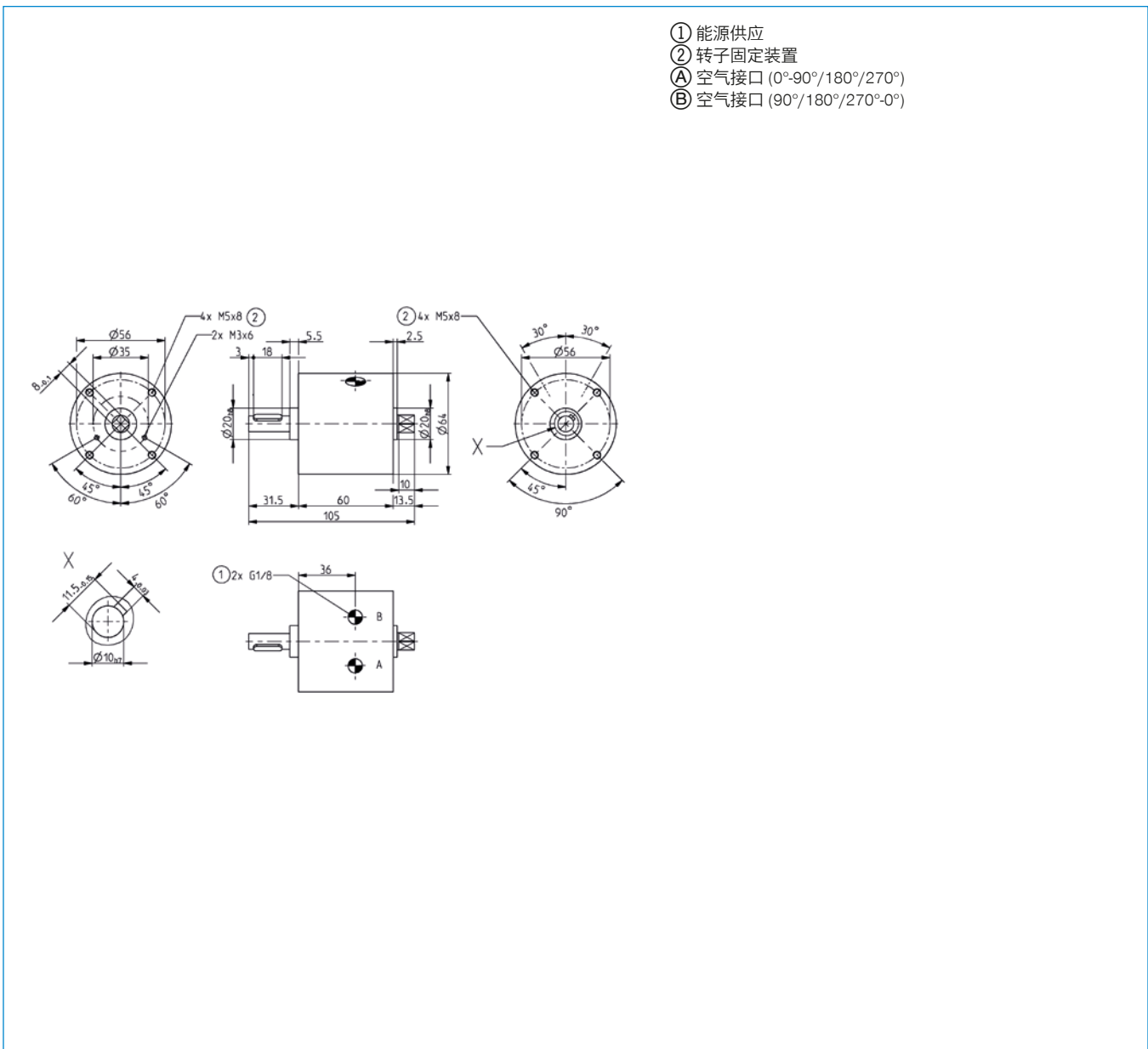

旋转气缸 配件 PRN系列

► 气动转子的油刹制动器



► 技术数据

订购编号	CRN50	CRN150	CRN300
可匹配于	PRN50	PRN150	PRN300
制动角 [°]	11	12	14
每次冲程的最大能量吸收 [Nm]	3	10	20
每次冲程的最大能量吸收 [Nm/h]	12000	43200	84000
最低操作温度 [°C]	5	5	5
最大操作温度 [°C]	50	50	50
重量 [g]	240	420	780

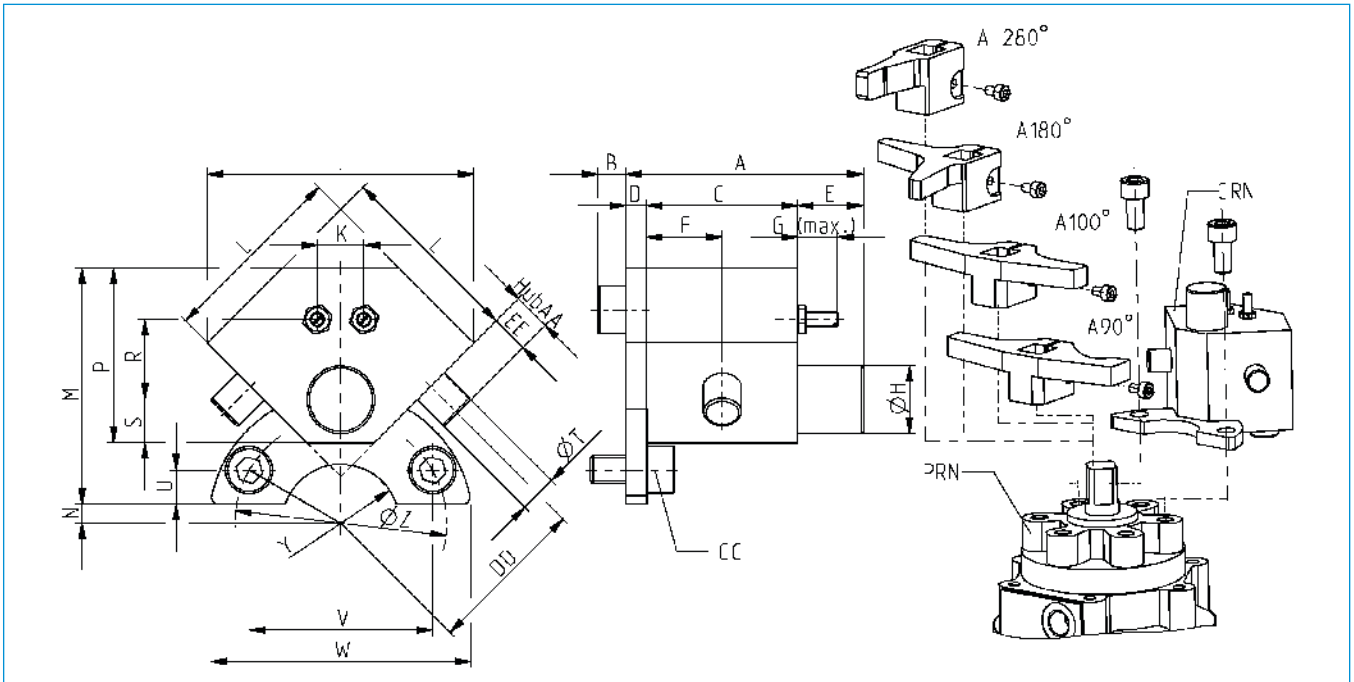

订购编号	A	B	C	D	E	F	G	H	J	K	L	M	N	P	R	S	T	U	V	W	Y	Z	AA	CC	DD	EE
CRN50	[mm]	[mm]	[mm]	[mm]	[mm]	[mm]	[mm]	[mm]	[mm]	[mm]	[mm]	[mm]	[mm]	[mm]	[mm]	[mm]	[mm]	[mm]	[mm]	[mm]	[mm]	[mm]	[mm]	[mm]	[mm]	[mm]
CRN150	50.6	6.0	3.2	4.5	14	16	8.5	Ø14.4	56.6	9.9	40	50	4.0	37	17.0	9.2	Ø8	7.2	39.0	56	R12,5	Ø45	6.5	M6x1x12	34	8
CRN300	62.5	7.2	4.2	4.5	16	21	12.0	Ø22.5	91.9	12.7	65	87	8.0	61	33.2	14.1	Ø12	12.0	69.2	95	R22,5	Ø80	15.0	M10x1,5x20	62	18

▶ 油刹制动器的止动杆



▶ 止停把手 PRN50

	▶ 技术数据		
订购编号	A50-90-B	A50-180-B	A50-270
摆动角度 [°]	90	180	270

▶ 止停把手 PRN150

	▶ 技术数据		
订购编号	A150-90-B	A150-180-B	A150-270
摆动角度 [°]	90	180	270

▶ 止停把手 PRN300

	▶ 技术数据		
订购编号	A300-90-B	A300-180-B	A300-270
摆动角度 [°]	90	180	270