

CLAMPING ELEMENT | PNEUMATIC

RBPS3500-A

▶ PRODUCT ADVANTAGES

- ▶ **sensing with process reliability**
Sensing of opened/closed state (optional)
- ▶ **Energize to open (NC)**
through spring-loaded energy storage
- ▶ **high durability**
5 million static clamping cycles
- ▶ **Safety element**
Safe braking in case of energy failure
- ▶ **Simple status sensing**
Querying the piston position with magnetic field sensor

▶ TECHNICAL DETAILS

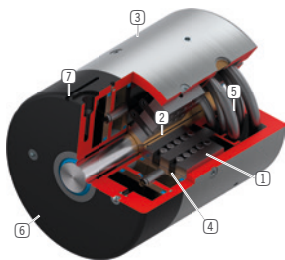

- ① **Wedge-type gear**
- Power transmission between piston and collet chuck
- ② **Collet chuck for clamping and braking**
- Pressed at the circular guide
- ③ **Housing**
- ④ **Pneumatic piston**
- The ring piston moves the wedge-type gear longitudinally
- ⑤ **Spring-loaded energy storage**
- For non-pressurized closing of the clamping unit
- ⑥ **Cover**
- ⑦ **Integrated slot (for size RBPS12 and larger)**
- Mounting and positioning of a magnetic field sensor (optional)

▶ INFORMATION ON THE PRODUCTS

APPLICATION SCENARIOS

- ▶ **Positioning of axes**
- ▶ **Fixing of vertical axes**
- ▶ **Positioning of lifting units**

FURTHER INFORMATION

- ▶ **Special variants on request, e.g.**
With low opening pressure (3.0 bar)

▶ RECOMMENDED ACCESSORIES



MFS02-K-KHC-P1-PNP
Magnetic field sensor straight, cable 5 m



MFS01-K-KHC-P1-PNP
Magnetic field sensor angled, cable 5 m



MFS02-S-KHC-P1-PNP
Magnetic field sensor straight, cable 0.3 m - M8 connector



MFS01-S-KHC-P1-PNP
Magnetic field sensor angled, cable 0.3 m - M8 connector

► TECHNICAL DRAWINGS

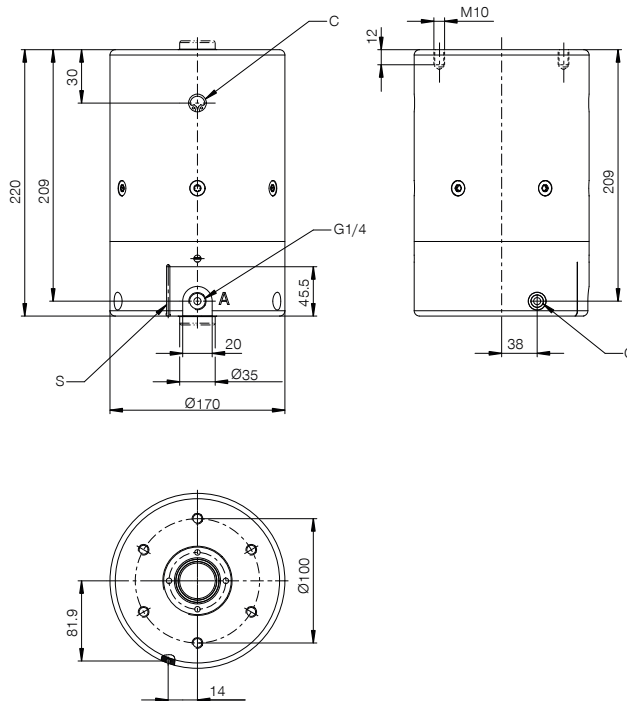

A:
Anschluss Öffnen
±30° zum Anschraubgewinde
Connection opening
±30° to the connection thread
C:
Entlüftung
Vent
S:
Abfragenut für Magnetfeldsensor
Sensing slot for magnetic field sensor

Ⓐ Connection opening ±30° to the connection thread

Ⓒ Quick exhaust valve



► TECHNICAL DATA

Order no.	RBPS3500-A
Operation	pneumatic
Holding force [N]	35000
Theoretical holding force ($\mu=0,1$) [N]	43,750
PLUS connection possible	No
Operating pressure [bar]	4 ... 6.5
B10d value	5,000,000
Positioning accuracy +/- [mm]	0,02
Opening time [s]	0.35
Closing time [s]	0.09
Operating temperature [°C]	-10 ... +70
Weight [kg]	22
Shaft Ø [mm]	35
Function	Clamping and braking
Condition	NC (Normally Closed) closed without pressure
Installation direction	from the front
Wiper	yes
Air volume per cycle [cm ³]	430
Sensor linkage	Sensing slot
Certifications	CE / UKCA / LABS / REACH / RoHS

Schematic drawing. General tolerances in accordance with DIN ISO 2768 T1-1/T2-H. Edges in accordance with ISO 13715. The element may only be used in the axial direction of movement. For rotational use, clarification with the technical department is required. Element has no guiding properties. Guidance must be provided externally. The holding force is the maximum force that can be applied in the axial direction. Each clamping and braking element is tested in a 100% inspection before delivery for the specified holding forces on a hardened round rail with a lightly oiled lubricating layer (ISO-VG 68). The use of other lubricants or rail coatings can influence the coefficient of friction. The operating instructions must be observed before commissioning. We reserve the right to make technical changes in the course of further development. The latest and further data can be found online and in the operating instructions at www.zimmer-group.com.