

CHANGEABLE JAW, FIX-PART WB5013F

CHANGEABLE JAW, LOOSE-PART-SET WB5013L

▶ PRODUCT SPECIFICATIONS



5 Changeable jaw, fix-part

4 Changeable jaw, loose-part-set

▶ Technical data

Order no.	WB5013F	WB5013L
Compatible with installation size	GPP5013 / GPD5013	GPP5013 / GPD5013
Tightening torque [Nm]	7	
Packaging unit [piece]	1	2
Weight [kg]	0.34	0.036

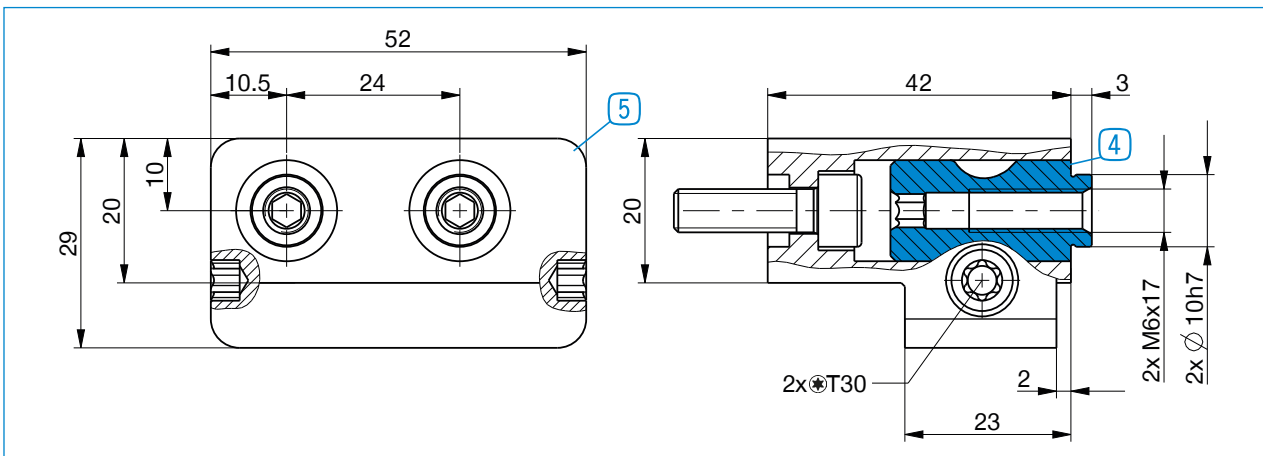

For each gripper jaw, one interchangeable jaw loose part set (4) and one interchangeable jaw fixed part (5) are needed