

TOOL CHANGERS

SERIES WPR5000

▶ PRODUCT ADVANTAGES

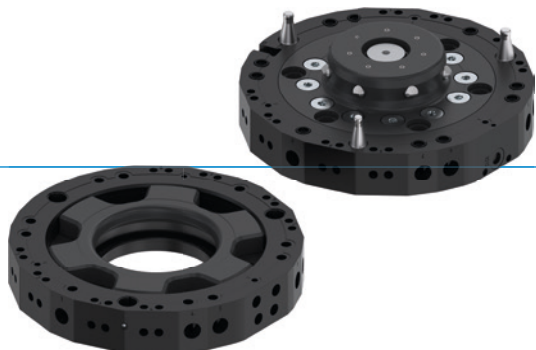

▶ Safer tool changer

Maximum safety due to a spring-loaded piston, self-locking mechanism, optional sensors and other accessories. The Zimmer Group tool changer therefore meets the requirements of Performance Level d, Control Category 3.





▶ Locking kinematics

The innovative locking kinematics with locking bolts and extreme rigidity is the new benchmark for tool changers. The extremely flat design also minimizes the torque load on the robot, which allows smaller and more cost-effective robots to be used.

▶ Endless variety

Regardless of the medium being transferred, with the right energy elements of the WER1500 and WER3000 series you get a standardized transmission of pneumatics, fluidics, electrical signals, power and communication and much more.

▶ SERIES CHARACTERISTICS

Installation size	Variants	
WPR5XXX	F-00-A	L-00-A
 Self locking mechanism	●	●
 5 million maintenance-free cycles (max.)	●	●
 Magnetic field sensor	●	●
 Protected against corrosion	●	●
 IP 54	●	●

► BENEFITS IN DETAIL

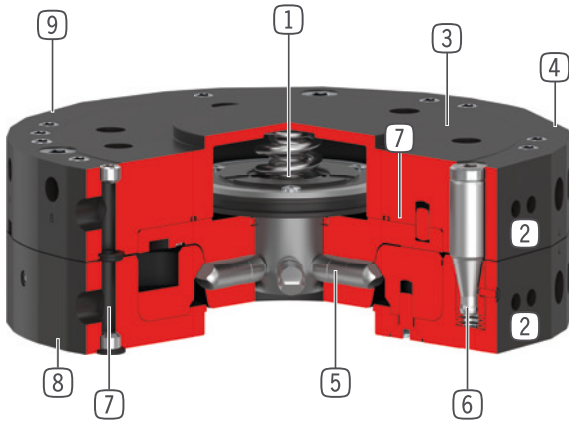

- 1 Drive**
 - Spring-loaded piston
 - Maximum safety thanks to a self-locking mechanism
 - Holds the loose part and tool securely even in the event of a pressure drop or an emergency stop
- 2 Mounting for energy element**
 - Side connection of the optional energy elements for the transmission of fluidics, electrical signals, power and communication and much more
- 3 Robot flange**
 - partial mounting circle in accordance with EN ISO 9409-1
- 4 Piston position sensing**
 - Optional integrated sensor system
 - Integrated directly in the tool changer, saving installation space and reducing the interference contour
- 5 Locking bolt**
 - All locking parts made of hardened steel
- 6 Centering pins**
 - Pretensioned centering pins for maximum torsional rigidity
- 7 Integrated air feed-through**
 - Air / vacuum transfer
 - Hoseless control possible
- 8 Loose part**
 - For installation by the customer
- 9 Fix part**
 - For robot side assembly

► TECHNICAL DATA

Installation size	Connecting flange according EN ISO 9409-1	Pneumatic energy transfer	Electrical energy transfer	Suitable energy elements
		[Quantity]		
WPR5031	TK 31.5	4	optional	4x WER1500
WPR5040	TK 40	4	optional	4x WER1500
WPR5050	TK 50	4	optional	4x WER1500
WPR5063	TK 63	6	optional	6x WER1500
WPR5080	TK 80	6	optional	8x WER1500
WPR5100	TK 100	8	optional	6x WER3000
WPR5125	TK 125	10	optional	8x WER3000
WPR5160	TK 160	10	optional	8x WER3000

► FURTHER INFORMATION IS AVAILABLE ONLINE



All information just a click away at: www.zimmer-group.com. Find data, illustrations, 3D models and operating instructions for your installation size using the order number for your desired product. Quick, clear and always up-to-date.

TOOL CHANGERS

INSTALLATION SIZE WPR5200

▶ PRODUCT SPECIFICATIONS



▶ Variable installation position

Shows the maximum handling weight depending on acceleration and lever arm. Does not replace the technical design.

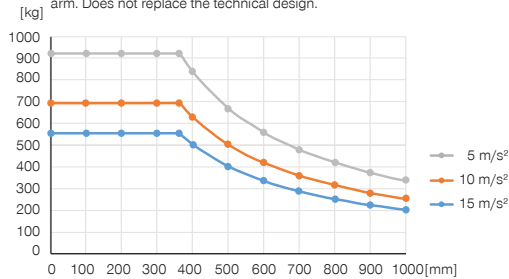

▶ Forces and moments

Shows the maximum forces and moments which may impact on the tool changer.

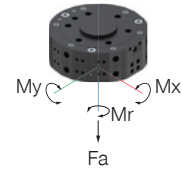

Mr [Nm]	5000
Mx [Nm]	6000
My [Nm]	6000
Fa [N]	40000

▶ INCLUDED IN DELIVERY



12 [piece]
O-Ring
COR0130150

▶ RECOMMENDED ACCESSORIES



ENERGY SUPPLY



GV1-8X8
Straight Fittings - Quick Connect Style



GV3-8X13ID
Straight Fittings - Barb Style Connection



WV1-8X8
Angled Fittings - Quick Connect Style



SENSORS



ZUB209020
Piston position sensing



NJR04-E2SK
Inductive Proximity Switch Cable 0,3 m - Connector M8



CONNECTIONS / OTHER



Energy elements and accessories for tool changers



AWPR5200-00-A
Storage station



AWPR5200-10-A
Storage station



ZUB190938
Programming tip



ZUB212160
Unlocking latch

Order no.	► Technical data	
	WPR5200F-00-A	WPR5200L-00-A
Connecting flange according EN ISO 9409-1	TK 200	TK 200
Type of drive	pneumatic	pneumatic
Suitable energy elements	12x WER3000	12x WER3000
Pneumatic energy transfer [Quantity]	12	12
Electrical energy transfer	optional	optional
Flow per connector [l/min]	1400	1400
Self locking mechanism when locking	mechanical	mechanical
Locking stroke [mm]	2.5	
Repetition accuracy in Z [mm]	0.01	0.01
Repetition accuracy in X, Y [mm]	0.02	0.02
Joining force [N]	10	
Release force [N]	10	
Offset at coupling max. in X,Y [mm]	2.5	2.5
Operating pressure [bar]	4 ... 10	4 ... 10
Nominal operating pressure [bar]	6	6
Operating temperature [°C]	5 ... +80	5 ... +80
Air volume per cycle [cm³]	366	
Moment of inertia [kgcm²]	888	269
Certifications	LABS / REACH / RoHS	LABS / REACH / RoHS
Weight [kg]	11	8.3

