

# CUTTING TONGS

## SERIES ZK1000

### ▶ PRODUCT ADVANTAGES



#### ▶ Extremely lightweight

This light weight generally allows the use of a smaller moving axis, reducing the overall costs of the application in the process





#### ▶ Integrated magnetic field sensing

One of the few cutting tongs on the market that can have its position queried and transferred to the control system with process reliability

#### ▶ Decide for yourself!

Sprue or steel wire: The variety of cutting geometries and materials ensure you always find the correct cuttings

### ▶ SERIES CHARACTERISTICS

Installation size	
ZK10XX	
 5 million maintenance-free cycles (max.)	●
 Spring opening O	●
 Magnetic field sensor	●
 IP30	●



## ► BENEFITS IN DETAIL

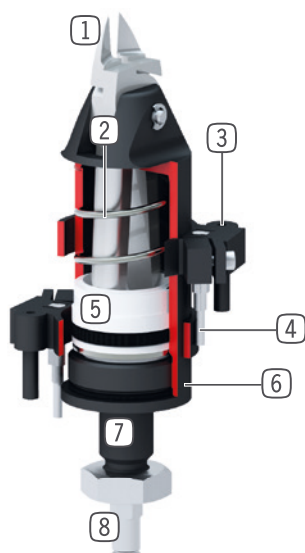

- ① **Cutting insert**
  - flexible applicable due to specific cutting geometry
- ② **Return spring**
  - to open the cuttings
- ③ **Mounting clamp**
  - mounting and positioning of magnetic field sensors
- ④ **Magnetic field sensor**
  - for position sensing
- ⑤ **Drive**
  - single-acting pneumatic cylinder
- ⑥ **Housing**
  - Hard-coated aluminum alloy
- ⑦ **Mounting and positioning**
  - via fit, thread and lock nut
- ⑧ **Energy supply**

## ► TECHNICAL DATA

Installation size	Stroke [°]	Gripping moment [Nm]	Weight [kg]	IP class
ZK1030	2.1	14	0.11	IP30
ZK1036	2.5	40	0.31	IP30
ZK1045	4.25	98	0.29	IP30
ZK1065	6.5	400	0.71	IP30

## ► FURTHER INFORMATION IS AVAILABLE ONLINE



All information just a click away at: [www.zimmer-group.com](http://www.zimmer-group.com). Find data, illustrations, 3D models and operating instructions for your installation size using the order number for your desired product. Quick, clear and always up-to-date.

# CUTTING TONGS

## INSTALLATION SIZE ZK1065

### ▶ PRODUCT SPECIFICATIONS



### ▶ INCLUDED IN DELIVERY



1 [piece]  
Locking nut  
C093620159

### ▶ RECOMMENDED ACCESSORIES



#### ENERGY SUPPLY



**GV1-8X8**  
Straight Fittings - Quick Connect Style



**WV1-8X8**  
Angled Fittings - Quick Connect Style



#### SENSORS



**KHD65**  
Sensor holder



**MFS02-K-KHC-P1-PNP**  
Magnetic field sensor straight, cable 5 m



**MFS02-S-KHC-P1-PNP**  
Magnetic field sensor straight, cable 0.3 m - M8 connector



#### CONNECTIONS / OTHER



**BK1065-01**  
Cutting Insert 15° for plastics



**BK1065-02**  
Cutting Insert 0° For Plastics



**BK1065-03**  
Cutting Insert 30° For Plastics



**BK1065-04**  
Cutting Tong For Plastics



**BK1065-05**  
Cutting Insert 0° For Steel

► Technical data	
<b>Order no.</b>	<b>ZK1065</b>
Stroke per jaw [°]	6.5
Gripping moment in closing [Nm]	400
Closing time [s]	0.1
Opening time [s]	0.4
Operating pressure min. [bar]	2
Operating pressure max. [bar]	6
Nominal operating pressure [bar]	6
Operating temperature min. [°C]	5
Operating temperature max. [°C]	+80
Air volume per cycle [cm³]	130
Weight [kg]	0.71
<b>Possible cutting diameters</b>	
possible cut-Ø max. plastics [mm]	11
possible cut-Ø max. hard-plastic [mm]	8
possible cut-Ø max. copper [mm]	6
possible cut-Ø max. steel [mm]	4

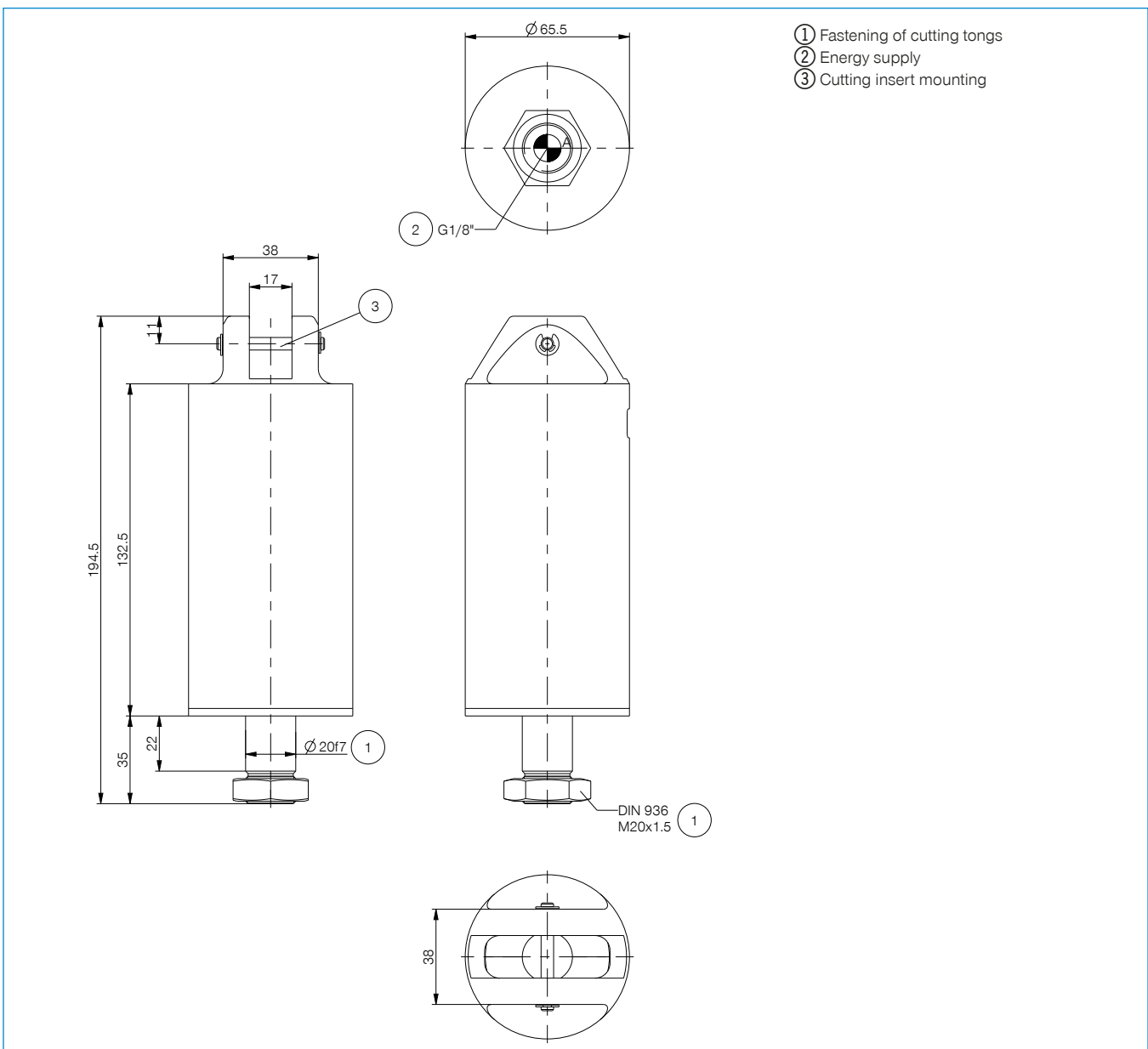

# CUTTING TONGS

## ZK1000 SERIES CUTTING INSERTS

### CUTTING INSERTS FOR ZK1030

**BK1030-01**

Cutting Insert 15° for plastics

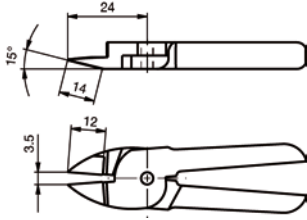

**BK1030-02**

Cutting Insert 40° For Plastics

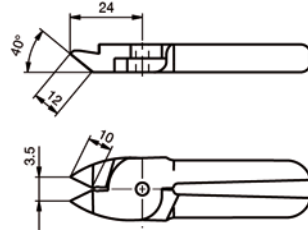

**BK1030-03**

Cutting Insert 0° For Plastics

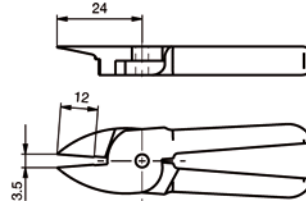

**BK1030-04**

Cutting Tong For Plastics

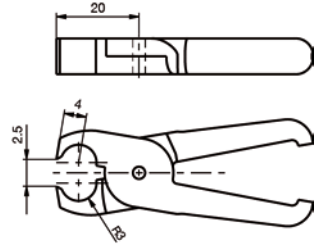

**BK1030-05**

Cutting Insert 0° For Steel

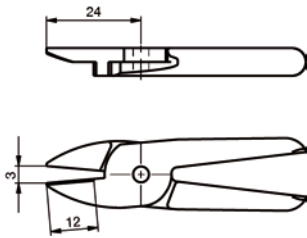

**BK1030-06**

Cutting Insert 25° For Steel

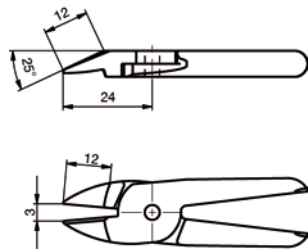

**BK1030-07**

Carbide cutting insert 0° for steel

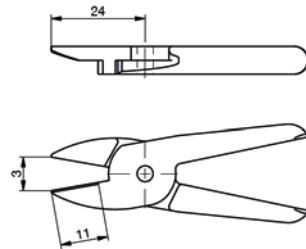

**BK1030-08**

Carbide Cutting Insert 25° For Steel

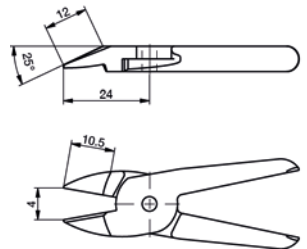

The appropriate cutting insert must be evaluated in terms of function and stability in the end application.

### CUTTING INSERTS FOR ZK1036

**BK1036-01**

Cutting Insert 25° For Plastics

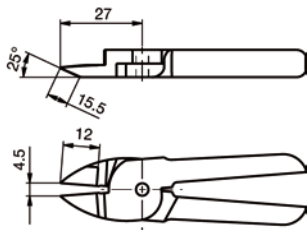

**BK1036-02**

Cutting Insert 40° For Plastics

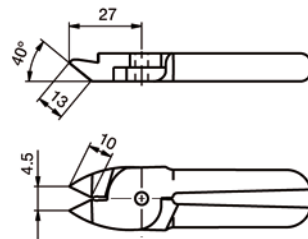

**BK1036-03**

Cutting Insert 0° For Plastics

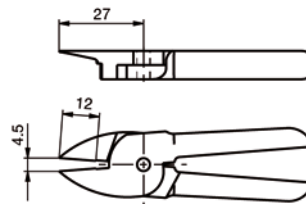

**BK1036-04**

Cutting Tong For Plastics

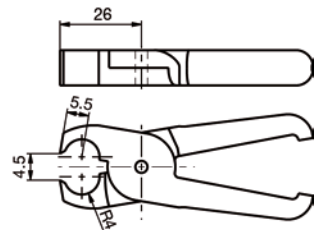

**BK1036-05**

Cutting Insert 0° For Steel

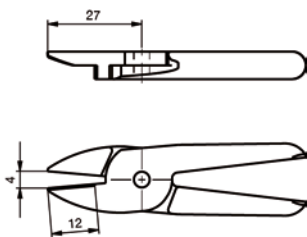

**BK1036-06**

Cutting Insert 25° For Steel

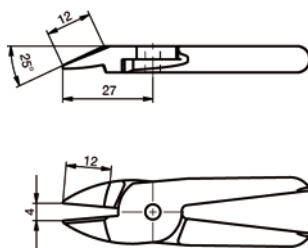

**BK1036-07**

Carbide cutting insert 0° for steel

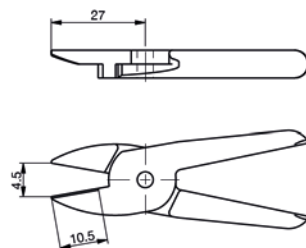

**BK1036-08**

Carbide Cutting Insert 25° For Steel

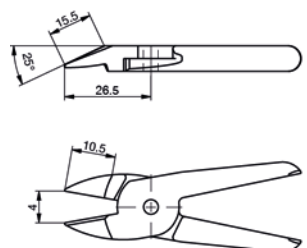

The appropriate cutting insert must be evaluated in terms of function and stability in the end application.

## CUTTING INSERTS FOR ZK1045

### BK1045-01

Cutting Insert 15° for plastics

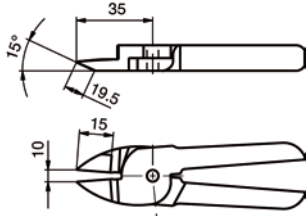

### BK1045-02

Cutting Insert 40° For Plastics

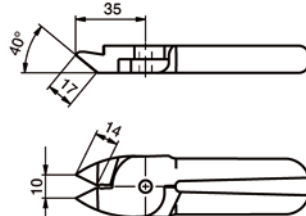

### BK1045-03

Cutting Insert 0° For Plastics

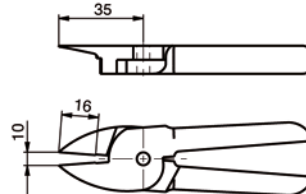

### BK1045-04

Cutting Tong For Plastics

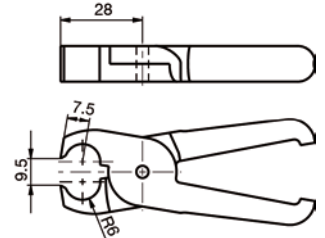

### BK1045-05

Cutting Insert 0° For Steel

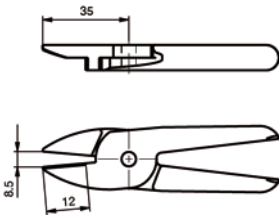

### BK1045-06

Cutting Insert 30° For Steel

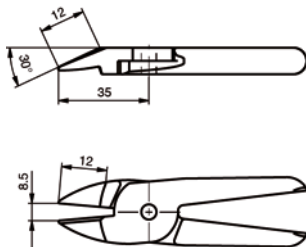

### BK1045-07

Carbide cutting insert 0° for steel

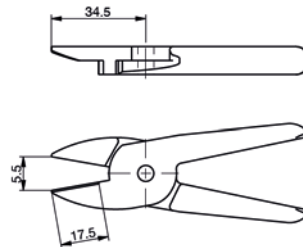

### BK1045-08

Carbide Cutting Insert 35° For Steel

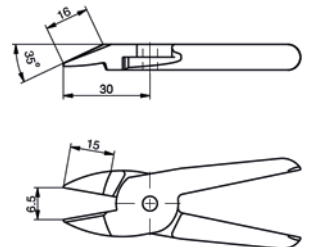

The appropriate cutting insert must be evaluated in terms of function and stability in the end application.

## CUTTING INSERTS FOR ZK1065

### BK1065-01

Cutting Insert 15° for plastics

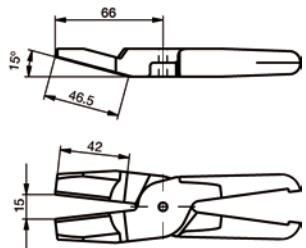

### BK1065-02

Cutting Insert 0° For Plastics

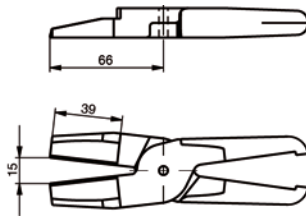

### BK1065-03

Cutting Insert 30° For Plastics

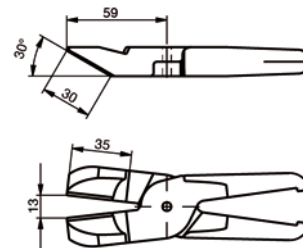

### BK1065-04

Cutting Tong For Plastics

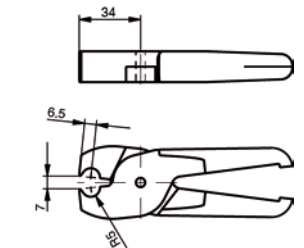

### BK1065-05

Cutting Insert 0° For Steel

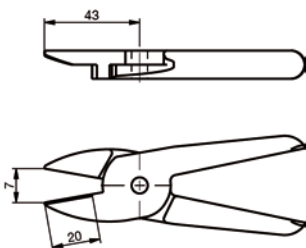

### BK1065-06

Cutting Insert 30° For Steel

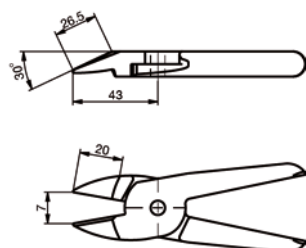

### BK1065-07

Carbide cutting insert 0° for steel

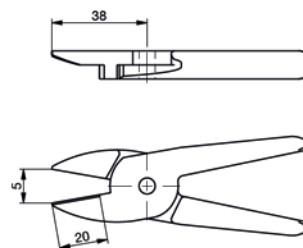

### BK1065-08

Carbide Cutting Insert 40° For Steel

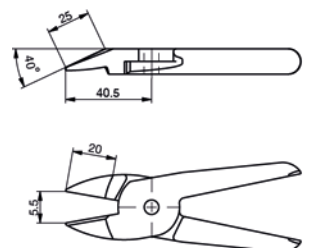

The appropriate cutting insert must be evaluated in terms of function and stability in the end application.