

切割钳

ZK1000 系列

▶ 产品优点



▶ 超轻

因为重量轻,所以可选小一号的移动轴,从而减少投入资金

▶ 配置磁性传感检测

市面上很少的可靠的可检测位置并由程序控制剪切工序的切割钳

▶ 您自己决定!

浇口和钢丝: 您可选择多种不同形状和材质的剪切刀来适合于您的应用

▶ 产品特点

尺寸型号

ZK10XX

 (最多)5 百万次循环免维护	●
 弹簧式自锁/常开	●
 磁场传感器	●
 IP30	●



优势细节

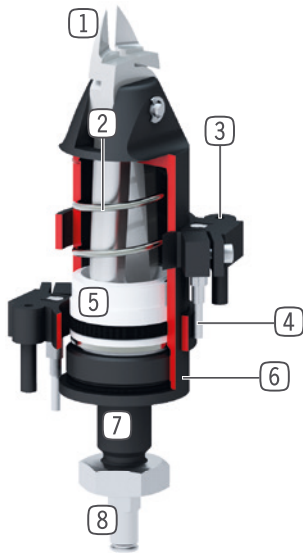

- ① 可替换刀口
- 对应特殊的剪切形状可灵活应用
- ② 回弹弹簧
- 复位刀口
- ③ 安装卡
- 用于放置安装磁性传感器
- ④ 磁性传感器
- 用于位置检测
- ⑤ 驱动
- 单作用气缸
- ⑥ 外壳
- 硬涂层铝合金
- ⑦ 安装和定位
- 通过插入式, 螺纹式和锁销式
- ⑧ 能源供应

技术数据

尺寸型号	行程 [°]	夹持力矩 [Nm]	重量 [kg]	IP 等级
ZK1030	2.1	14	0.11	IP30
ZK1036	2.5	40	0.31	IP30
ZK1045	4.25	98	0.29	IP30
ZK1065	6.5	400	0.71	IP30

更多详情请上网查询



所有信息查询请点击:www.zimmer-group.com。产品参数、绘图、3D模型和操作说明均可根据产品型号查询。清晰且实时更新。

切割钳

ZK1065 尺寸型号

▶ 产品规格



▶ 随货提供

	1 [片] 锁紧螺母 C093620159
---	-----------------------------

▶ 配件建议

能源供应

	GV1-8X8 直插接头-快接式
	WV1-8X8 角度接头-快接式

传感器

	KHD65 传感器支架
	MFS02-K-KHC-P1-PNP 磁场传感器直的, 电缆5m
	MFS02-S-KHC-P1-PNP 磁场传感器直的, 电缆0.3m-插头M8

接口 / 其他

	BK1065-01 用于剪切塑料15°可换剪头
	BK1065-02 用于剪切塑料0°可换剪头
	BK1065-03 用于剪切塑料30°可换剪头
	BK1065-04 用于剪切塑料剪头
	BK1065-05 用于剪切钢铁 0°可换剪头

▶ 技术数据	
订购编号	ZK1065
单边行程 [°]	6.5
闭合抓取力矩 [Nm]	400
闭合时间 [s]	0.1
张开时间 [s]	0.4
最小操作气压 [bar]	2
最大操作气压 [bar]	6
额定操作气压 [bar]	6
最低操作温度 [°C]	5
最高操作温度 [°C]	+80
每循环耗气体积 [cm ³]	130
重量 [kg]	0.71
可能的切削直径	
最大可剪切直径Ø (塑料) [mm]	11
最大可剪切直径Ø (硬塑料) [mm]	8
最大可剪切直径Ø (铜) [mm]	6
最大可剪切直径Ø (钢) [mm]	4

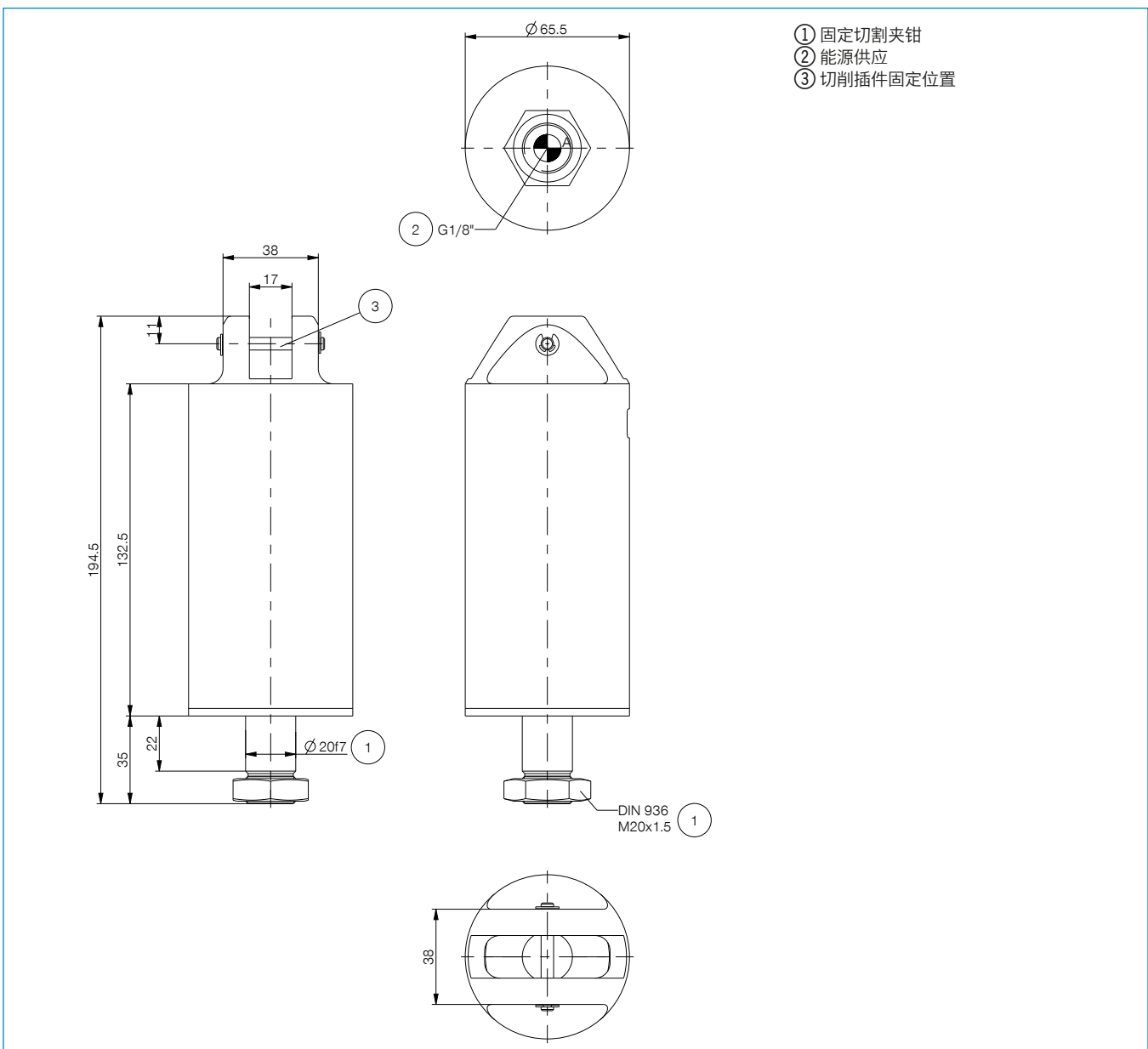

切割钳

ZK1000 系列切削插件

► ZK1030 的切削插件

BK1030-01

用于剪切塑料15°可换剪头

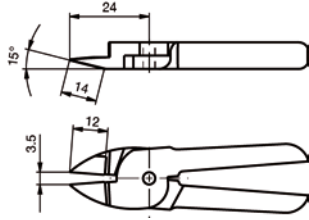

BK1030-02

用于剪切塑料40°可换剪头

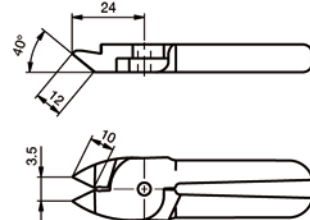

BK1030-03

用于剪切塑料0°可换剪头

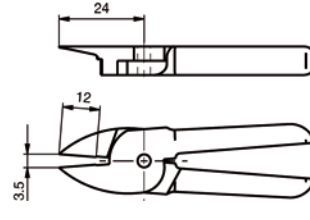

BK1030-04

用于剪切塑料剪头

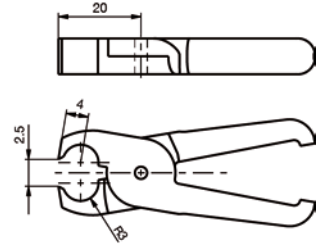

BK1030-05

用于剪切钢铁 0°可换剪头

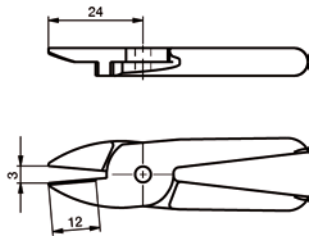

BK1030-06

用于剪切钢铁 25°可换剪头

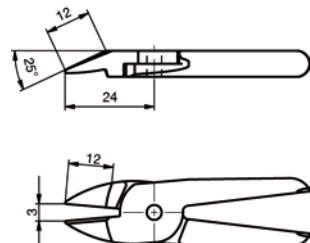

BK1030-07

用于钢材的 0° 硬质合金切削插件

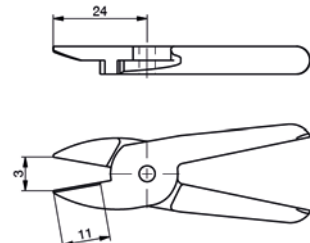

BK1030-08

用于剪切钢铁可换25°剪头

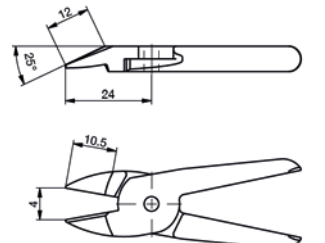

必须根据最终应用中的功能和稳定性来评估合适的切削刀片。

► ZK1036 的切削插件

BK1036-01

用于剪切塑料25°可换剪头

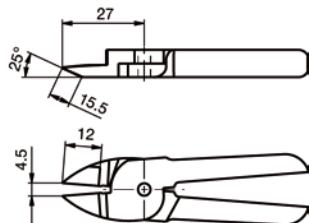

BK1036-02

用于剪切塑料40°可换剪头

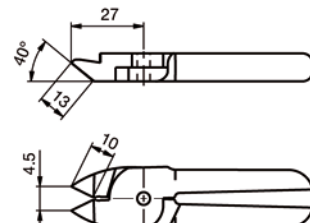

BK1036-03

用于剪切塑料0°可换剪头

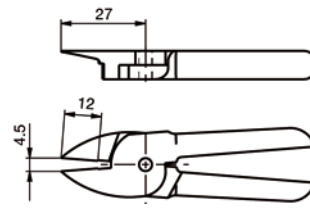

BK1036-04

用于剪切塑料剪头

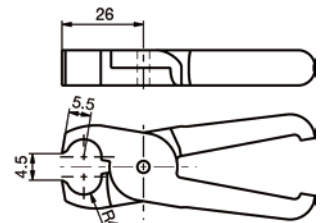

BK1036-05

用于剪切钢铁 0°可换剪头

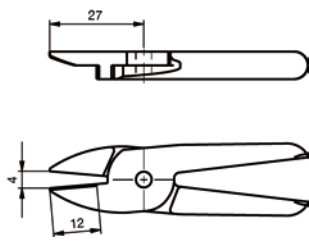

BK1036-06

用于剪切钢铁 25°可换剪头

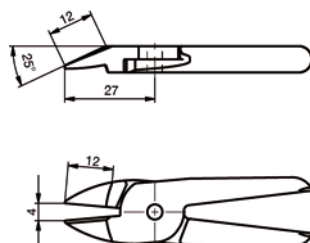

BK1036-07

用于钢材的 0° 硬质合金切削插件

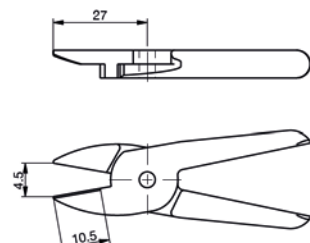

BK1036-08

用于剪切钢铁可换25°剪头

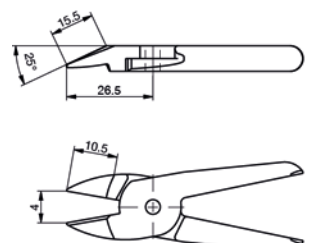

必须根据最终应用中的功能和稳定性来评估合适的切削刀片。

► ZK1045 的切削插件

BK1045-01

用于剪切塑料15°可换剪头

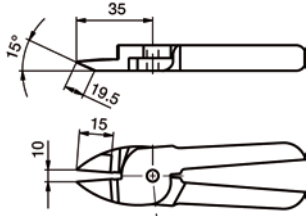

BK1045-02

用于剪切塑料40°可换剪头

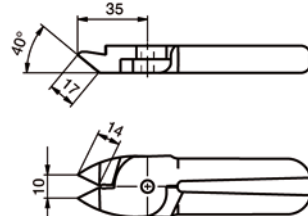

BK1045-03

用于剪切塑料0°可换剪头

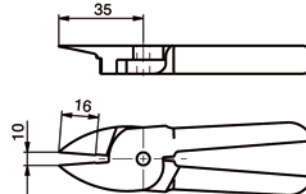

BK1045-04

用于剪切塑料剪头

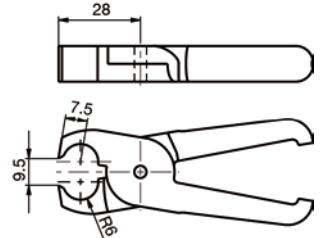

BK1045-05

用于剪切钢铁 0°可换剪头

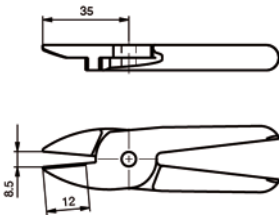

BK1045-06

用于剪切钢铁 30°可换剪头

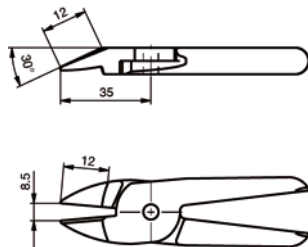

BK1045-07

用于钢材的 0° 硬质合金切削插件

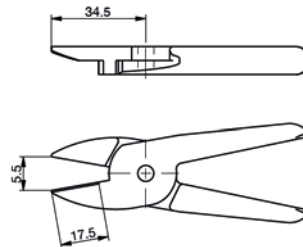

BK1045-08

用于剪切钢铁可换35°剪头

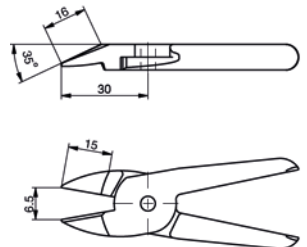

必须根据最终应用中的功能和稳定性来评估合适的切削刀片。

► ZK1065 的切削插件

BK1065-01

用于剪切塑料15°可换剪头

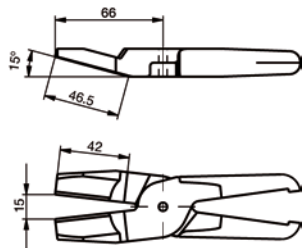

BK1065-02

用于剪切塑料0°可换剪头

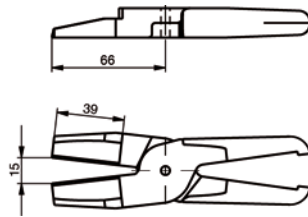

BK1065-03

用于剪切塑料30°可换剪头

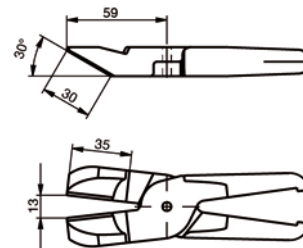

BK1065-04

用于剪切塑料剪头

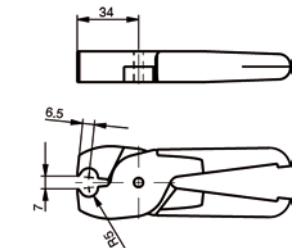

BK1065-05

用于剪切钢铁 0°可换剪头

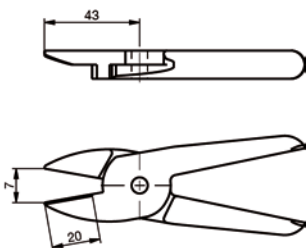

BK1065-06

用于剪切钢铁 30°可换剪头

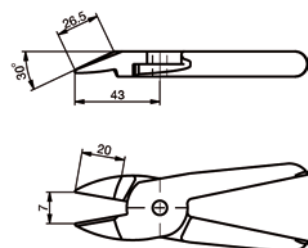

BK1065-07

用于钢材的 0° 硬质合金切削插件

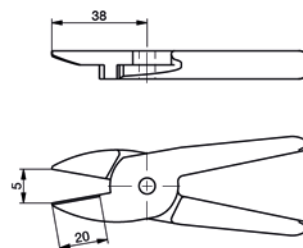

BK1065-08

用于剪切钢铁可换40°剪头

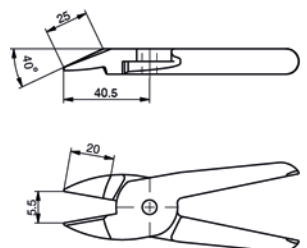

必须根据最终应用中的功能和稳定性来评估合适的切削刀片。