

PISTON POSITION SENSING

ZUB088923

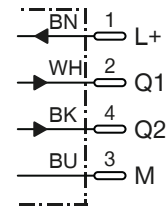

Connection diagram

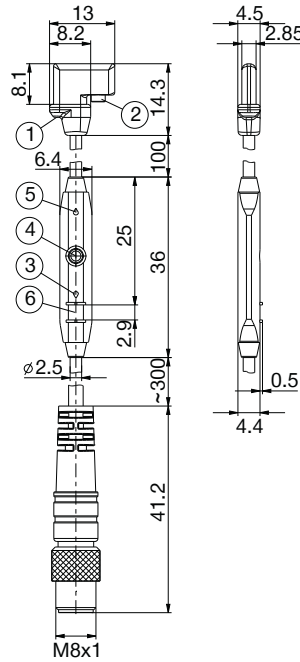

PIN assignment

- ① Center of sensor element
- ② Fixing screw
- ③ Display LED
- ④ Teach-in button
- ⑤ Display LED
- ⑥ Ribs for cable ties

Order no.	ZUB088923
General data	
Compatible with installation size	WWR125
Cylinder design	C-slot
Switching output	PNP
Switching frequency [Hz]	7000
Switching function	Normally open (NO)
Programmable switching points	2
Electrical version	DC 4-wire
Protection to IEC 60529	IP67
Certification	CE
Electrical / Mechanical data	
Supply voltage min. [V DC]	12
Supply voltage max. [V DC]	30
Current consumption [mA]	≤15
Voltage drop [V]	≤2.2
Continuous current [mA]	≤100
Detection zone [mm]	Fehlende Variable
Hysteresis typ. [mT]	0.795
Reproducibility [mT]	≤0.1
Protected against polarity reversal	Yes
Short-circuit-proof	Yes
Power-up pulse protection	Yes
Operating temperature min. [°C]	-20
Operating temperature max. [°C]	+75
Shock and vibration resistance	30 g, 11 ms / 10 ... 55 Hz, 1 mm
Housing Material	Plastics
Connection type	Cable/Connector
Fixing thread	M8
Installation type	Cable outlet radial
Cable length [m]	0.3
Nr. of wires x diameter [mm ²]	4x0.08
Cable sheath material	PUR
Bending radius for fixed routing, min.	3xØ
Bending radius when using a drag chain, min.	5xØ