



## INSTALLATION AND OPERATING INSTRUCTIONS

2-jaw parallel gripper

HRC-03

IO-Link, positionable

Software version SWA000226\_C00

DDOC01487

THE KNOW-HOW FACTORY

## Glossary

Term	Explanation
ActualPosition	Value of the current jaw position [1/100 mm]
BasePosition	Outer jaw position Depending on the application, this can be the base position or the work position.
ControlWord	Activation of the product Only one bit is permitted to be active in the ControlWord. The value 0 is also permitted.
DeviceMode	Used to select gripping profiles as well as the additional help modes in the product.
Diagnosis	If an error occurs, outputs a diagnostic code that can be compared with the error list.
GND	Ground/earth
GripForce	Setting the gripping force
PositionTolerance	Tolerance range for TeachPosition The value of the parameter acts in both directions.
ShiftPosition	ShiftPosition is a switching position between pre-positioning and gripper movement.
StatusWord	Summary of binary states of the product that can be returned as information to the control system.
Teach	Adoption of the ActualPosition as the TeachPosition
TeachPosition	Taught-in workpiece position
Travel path	Path on which the gripper jaws travel.
WorkpieceNo	Number of the selected workpiece recipe
WorkPosition	Inner jaw position Depending on the application, this can be the standby position or the work position.
Workpiece loss detection	Function which, in case of a workpiece loss, causes the jaws to move to the end position.

## Content

1	Introduction .....	5
1.1	Supporting documents .....	5
1.2	Notices and graphics in the instructions .....	5
2	Safety notices .....	6
3	Proper use .....	7
4	Personnel qualification .....	8
4.1	Electricians .....	8
4.2	Specialists .....	8
4.3	Instructed personnel.....	8
4.4	Service personnel.....	8
4.5	Additional qualifications .....	8
5	Product description .....	9
5.1	Possible applications.....	9
5.2	Type plate .....	9
5.3	Use in applications .....	10
6	Functional description .....	11
6.1	LED status display .....	12
7	Technical data .....	12
8	Accessories/scope of delivery .....	12
9	Transportation/storage/preservation .....	12
10	Installation .....	13
10.1	Installing the product.....	14
10.2	Safe shutoff for products with IO-Link.....	15
10.3	Installing the energy supply .....	16
10.3.1	HRC-03-138553 pin assignment.....	16
10.3.2	Pin assignment of the Y plug-in connector.....	17
10.4	Static charge .....	18
10.5	Heat dissipation .....	18
10.6	Installing accessories .....	18
11	Commissioning .....	19
11.1	Process data .....	20
11.2	IODD Import .....	21
11.3	Data transmission via handshake.....	21
11.4	Parameters .....	22
11.4.1	ControlWord.....	22
11.4.2	DeviceMode.....	24
11.4.3	WorkpieceNo .....	28
11.4.4	PositionTolerance .....	28
11.4.5	GripForce .....	29
11.4.6	DriveVelocity .....	29
11.4.7	BasePosition .....	30
11.4.8	TeachPosition.....	30
11.4.9	WorkPosition .....	30
11.4.10	StatusWord.....	31
11.4.11	Diagnosis.....	33
11.4.12	ActualPosition .....	33
11.5	Cold start .....	34
11.6	Minimum travel path .....	34
11.7	Minimum positioning path .....	34

- 11.8 Easy Startup .....34
- 11.9 Quickstart Basic Parameters .....35
- 11.10 Starting jaw movement.....35
- 11.11 Starting the jaw movement from any position (EasyMode).....36
  - 11.11.1 EasyMode Standard .....36
  - 11.11.2 EasyMode Restricted .....37
- 11.12 Workpiece loss detection.....38
  - 11.12.1 Current profile during the gripping process.....38
  - 11.12.2 Modifying workpiece loss detection .....38
- 11.13 Repeated movements in the same direction.....39
- 11.14 Recipe examples .....40
  - 11.14.1 Save recipe.....40
  - 11.14.2 Loading a recipe .....41
- 12 Operation..... 42
  - 12.1 Setting the gripping force.....42
  - 12.2 Emergency release.....42
- 13 Gripping force charts..... 43
- 14 Error diagnosis ..... 44
  - 14.1 Status of the LED display .....45
- 15 Table with acyclic data (ISDU) ..... 47
- 16 Maintenance..... 50
- 17 Decommissioning/disposal ..... 50
- 18 RoHS declaration..... 51
- 19 Declaration of Incorporation (Machinery Directive) ..... 52
- 20 Declaration of Incorporation ..... 53
- 21 Declaration of Conformity ..... 54

## 1 Introduction

### 1.1 Supporting documents

#### NOTICE



Read through the instructions before installing or working with the product.

The instructions contain important notes for your personal safety. They must be read and understood by all persons who work with or handle the product during any phase of the product lifetime.



The documents listed below are available for download on our website [www.zimmer-group.com](http://www.zimmer-group.com).

- Instructions
  - Catalogs, drawings, CAD data, performance data
  - Information on accessories
  - Technical data sheets
  - General Terms and Conditions, including warranty information.
- ⇒ Only those documents currently available on the website are valid.

#### INFORMATION



These installation and operating instructions are valid for software version SWA000226\_C00.

- ▶ Contact Customer Service for installation and operating instructions for older software versions.

In these instructions, "product" refers to the product designation on the title page!

### 1.2 Notices and graphics in the instructions

#### DANGER



This notice warns of an imminent danger to the life and health of people. Ignoring these notices can lead to serious injury or even death.

- ▶ You absolutely must comply with the described measures for avoiding these dangers!
- ⇒ The warning symbols are assigned according to the type of danger.

#### WARNING



This notice warns of a situation that is potentially hazardous to personal health. Ignoring these notices can cause serious injury or damage to health.

- ▶ You absolutely must comply with the described measures for avoiding these dangers!
- ⇒ The warning symbols are assigned according to the type of danger.

#### CAUTION



This notice warns of a situation that is potentially hazardous to persons. Ignoring these notices can cause minor, reversible injuries.

- ▶ You absolutely must comply with the described measures for avoiding these dangers!
- ⇒ The warning symbols are assigned according to the type of danger.

#### NOTICE



This notice warns of possible material and environmental damage. Ignoring these notices can result in damage to the product or the environment.

- ▶ You absolutely must comply with the described measures for avoiding these dangers!
- ⇒ The warning symbols are assigned according to the type of danger.

#### INFORMATION



This category contains useful tips for handling the product efficiently. Failure to observe these tips will not result in damage to the product. This information does not include any information relevant to health or workplace safety.

## 2 Safety notices

### CAUTION



#### Risk of injury and material damage in case of non-compliance

The product is state-of-the-art.

The following are examples of situations in which the product may cause a hazard:

- The product is not properly installed, used or maintained.
- The product is not used for its designated purpose.
- The locally applicable regulations, laws, directives or guidelines are not observed.
- ▶ The product may only be used in accordance with these instructions and the product's technical data. Any changes or additions to the intended use of the product, as well as modifications to the product, such as those in the following examples, require the written permission of the manufacturer:
  - Use of the product under extreme conditions, such as aggressive fluids or abrasive dusts
  - Additional drilled holes or threads
- ⇒ Zimmer Group GmbH shall accept no liability for any damage caused by improper use. The operator bears sole responsibility.
- ▶ Make sure that the power supply is disconnected before you mount, adjust, modify, maintain or repair the product.
- ▶ Whenever work is carried out on the product, make sure that the product cannot be actuated by mistake.
- ▶ Perform maintenance tasks, renovation work or attachment work outside of the machine's danger zone when possible.
- ▶ Do not reach into the operational range of the product.
- ▶ Always adhere to the required maintenance intervals.
- ▶ When using the product under extreme conditions, adjust the maintenance interval according to the degree of contamination.
- ▶ Check the completeness and tightening torques of all mounting screws.

The suitability of the product for collaborative use can only be verified while using gripper fingers installed in factory condition.

- ▶ If using other gripper fingers, check the permitted maximum force and pressure values for collaborative operation.

## CAUTION



### Notes and handling regulations for electrostatically sensitive components

Electrostatically sensitive components are individual components, integrated circuits or assemblies that can be damaged by electrostatic fields or electrostatic discharge.

- ▶ When handling electrostatic components, make sure that persons, the work area and packaging are all fully grounded.
- ▶ Touch electronic components only in appropriately identified areas with conductive flooring and only if:
  - You are grounded by means of special bracelets.
  - You wear shoes that are suitable and approved for the discharge of electrostatic charges.
- ▶ Do not bring electronic assemblies into contact with plastics and parts of clothing that have plastic content.
- ▶ Store electronic assemblies on conductive underlays only.
- ▶ Do not install electronic assemblies in the vicinity of data back-up devices or monitors (monitor distance > 100 mm).
- ▶ Perform measurements on electronic assemblies only if:
  - The measuring instrument is grounded (e.g. via a ground conductor).
  - The measuring head is momentarily discharged before measuring with a floating measuring instrument.

## NOTICE



### Cybersecurity

- ▶ The operator is responsible for ensuring that unauthorized persons do not have access to the product, either physically or remotely.

## 3 Proper use

### NOTICE



### Material damage and malfunction in case of non-compliance

The product is only to be used in its original state with its original accessories, with no unauthorized changes and within the stipulated parameter limits and operating conditions.

Any other or secondary use is deemed improper.

- ▶ Operate the product only in compliance with the associated instructions.
  - ▶ Operate the product only when it is in a technical condition that corresponds to the guaranteed parameters and operating conditions.
- ⇒ Zimmer Group GmbH shall accept no liability for any damage caused by improper use. The operator bears sole responsibility.

- The product is to be used as intended in enclosed rooms for temporary gripping, handling and holding.
- The product is intended for industrial use.
- The product is not suited for use in a potentially explosive atmosphere.
- Direct contact with perishable goods/food is not permitted.
- The product must always be mounted on materials that dissipate heat.
- The product is not suitable for clamping workpieces during a machining process.
- The product is designed exclusively for electric operation using a 24 V DC power supply.

## 4 Personnel qualification

### WARNING



#### **Inadequate qualification can cause injury and material damage**

If inadequately qualified personnel perform work on the product, this can cause serious injuries and significant material damage.

- ▶ All work on the product must be performed by qualified personnel.
- ▶ Before working with the product, read the document in its entirety and make sure that you have understood everything.
- ▶ Observe country-specific accident prevention regulations and the general safety notices.

The following qualifications are a prerequisite for performing various work on the product.

#### **4.1 Electricians**

Electricians are able to perform work on electrical systems, can recognize and avoid possible dangers and know the relevant standards and provisions due to their technical training, knowledge and experience.

#### **4.2 Specialists**

Specialists are able to perform the assigned work, can recognize and avoid possible dangers and know the relevant standards and provisions due to their technical training, knowledge and experience.

#### **4.3 Instructed personnel**

Instructed personnel have been trained by the operating company on the tasks and possible dangers of improper behavior.

#### **4.4 Service personnel**

Service personnel are able to perform the assigned work and can recognize and avoid possible dangers due to their technical training, knowledge and experience.

#### **4.5 Additional qualifications**

Persons who work with the product must be familiar with the valid safety regulations and laws as well as the standards, guidelines and laws listed in this document.

Personnel who work with the product must have facility-issued authorization to commission, program, configure, operate, maintain and also decommission this product.

## 5 Product description

### 5.1 Possible applications

#### Outside gripping

The product can be used for outside gripping.  
MoveToWork command

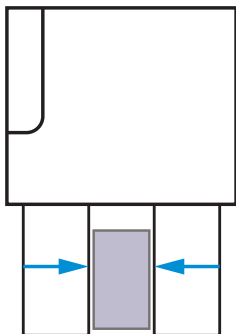

#### Inside gripping

The product can be used for inside gripping.  
MoveToBase command

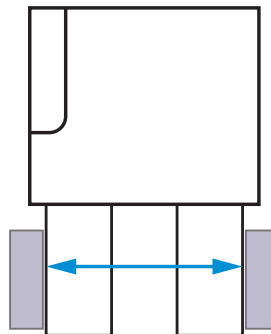

### 5.2 Type plate

A type plate is attached to the product.

- ① Article number
- ② Confirmation number

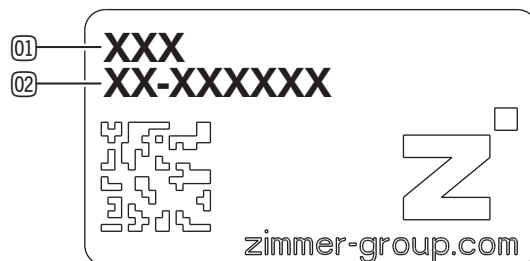

### 5.3 Use in applications

The criteria listed below justify the suitability of the product for use in collaborative applications:

- The product has been designed in accordance with the specifications of ISO/TS 15066.
- The torque of the motor in combination with the transmission design and the pre-assembled gripper jaws is not sufficient to generate a gripping force > 140 N upon vulnerable areas of the body.
- The gripping forces generated when gripping soft objects are significantly reduced, since the amount of dynamic force is lowered. Compliance with the maximum permitted gripping force has been verified by a suitable measuring instrument.
- The product is engineered to be inherently safe and is designed with rounded edges and shapes that prevent crushing and shearing points from being created.

#### Automation cell

Separated workspaces



#### Coexistence

Detection of presence

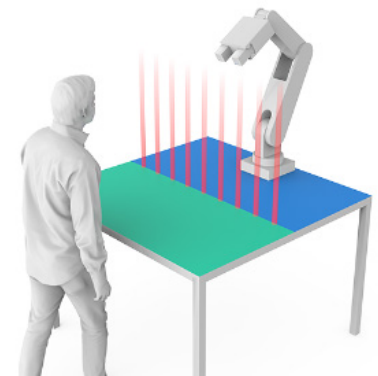

#### Cooperation

Zones of action

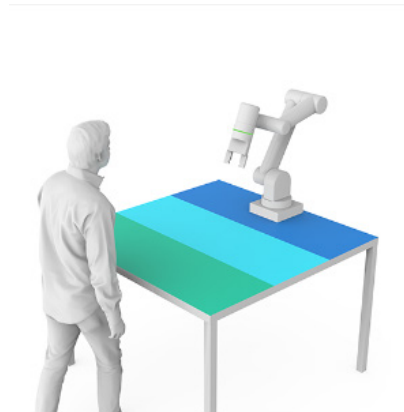

#### Collaboration

Shared workspaces

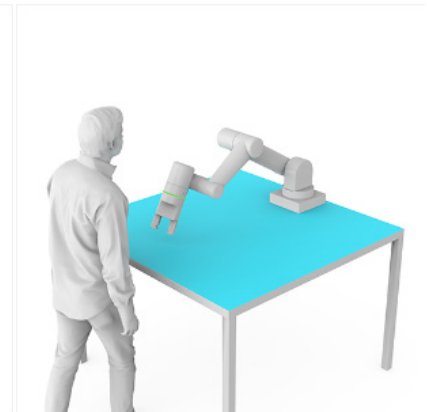

## 6 Functional description

The gripper jaws of the product are arranged parallel to each other on two opposing guide rails and can be moved relative to each other.

The force of the motor is transmitted over a gear to a worm gear. The movement is transferred from the worm gear to the toothed gripper jaws and a synchronized movement is generated.

The product has a mechanical self-locking mechanism to ensure that the workpiece remains held in the event of a power supply loss.

The product can be easily integrated into available control systems and controlled via IO-Link.

The gripping force can be adapted optimally to the workpiece conditions via IO-Link.

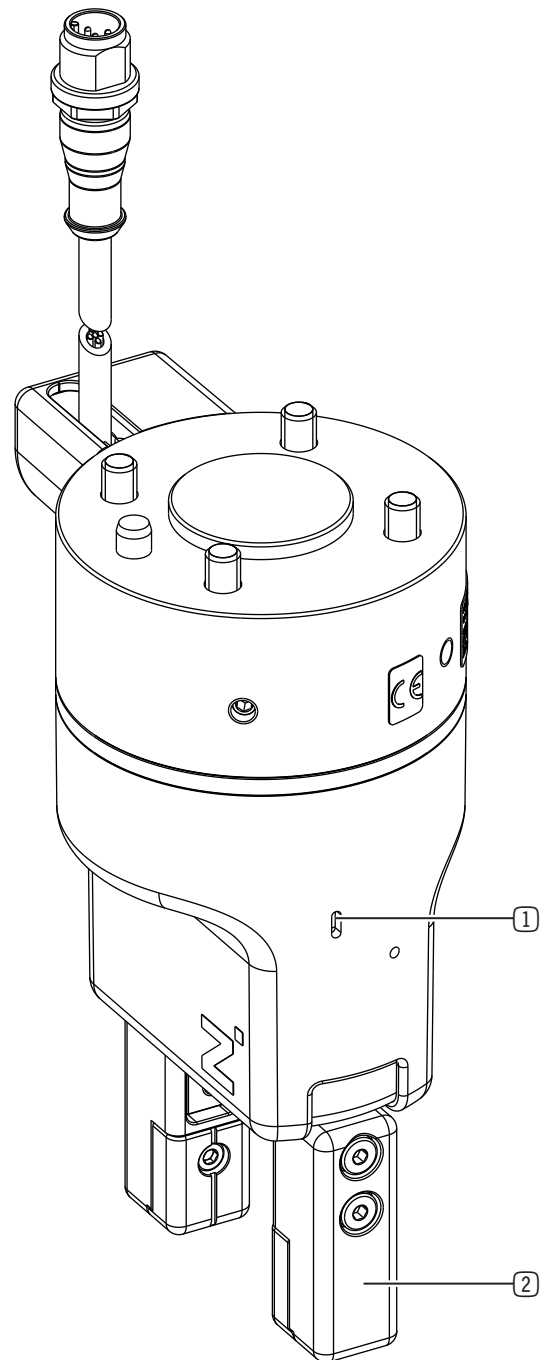

- ① LED display
- ② Gripper jaw

## 6.1 LED status display

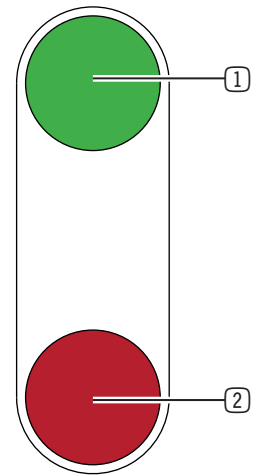

- ① Power/communication
- ② Error

## 7 Technical data

### INFORMATION



- ▶ You can find the information in the technical data sheet on our website.
- This data varies within the series, depending on the specific design.

## 8 Accessories/scope of delivery

### INFORMATION



- If any accessories not sold or authorized by Zimmer Group GmbH are used, the function of the product cannot be guaranteed. Zimmer Group GmbH accessories are specifically tailored to the individual products.
- ▶ For optional accessories and those included in the scope of delivery, refer to our website.

## 9 Transportation/storage/preservation

- ▶ Transport and storage of the product must be done only with the original packaging.
- ▶ If the product has already been installed on the superordinate machine unit, care must be taken during transport to ensure that no unexpected movements can occur.
  - ▶ Before commissioning the product and after transport, check all power and communication connections as well as all mechanical connections.
- ▶ If the product is stored for an extended period, the following points are to be observed:
  - ▶ Keep the storage location as dust-free and dry as possible.
  - ▶ Avoid temperature fluctuations.
  - ▶ Avoid wind/drafts/water condensation formation.
  - ▶ Pack the product and do not expose it to direct sunlight during storage.
- ▶ Clean all components. There must be no soiling left on the components.
- ▶ Visually inspect all components.
- ▶ Remove all foreign substances.
- ▶ Properly remove potential corrosion spots.
- ▶ Close electrical connections using suitable covers.

## 10 Installation

### WARNING



#### Risk of injury due to uncontrolled movements

Risk of injury in case of unexpected movement of the machine or system into which the product is to be installed.

- ▶ Switch off the energy supply of the machine before any work.
- ▶ Secure the power supply against being switched on unintentionally.
- ▶ Check the machine for any residual energy that may be present.

### CAUTION



#### Risk of injury due to uncontrolled movements

Risk of injury in the event of uncontrolled movement of the product when the power supply is connected.

- ▶ Switch off the power supply to the machine before carrying out any work.
- ▶ Secure the power supply against being switched on unintentionally.
- ▶ Check the machine for any residual energy that may be present.

### Assembly requirements

Permissible flatness tolerance [mm]	0,03
Strength class of the mounting screws	8.8

### INFORMATION



Further installation information:

- The mounting screws are not included in the scope of delivery.

- ▶ Install the product on an appropriate mounting surface in accordance with the flatness specifications.
- ▶ Make sure that the mounting piece is sufficiently rigid.
- ▶ Ensure the cleanliness of the connection surfaces.
- ▶ Please note the permitted tightening torques of the mounting screws at [www.zimmer-group.com/en/td](http://www.zimmer-group.com/en/td).

### 10.1 Installing the product

- ▶ Unscrew the grub screws.
- ▶ Remove the connecting flange.
- ▶ Center the connecting flange on the mounting piece with the straight pin.
- ▶ Install the connecting flange on the mounting piece with the mounting screws.
- ▶ Slide the product into the connecting flange again.
- ▶ Install the product onto the connecting flange with the grub screws.

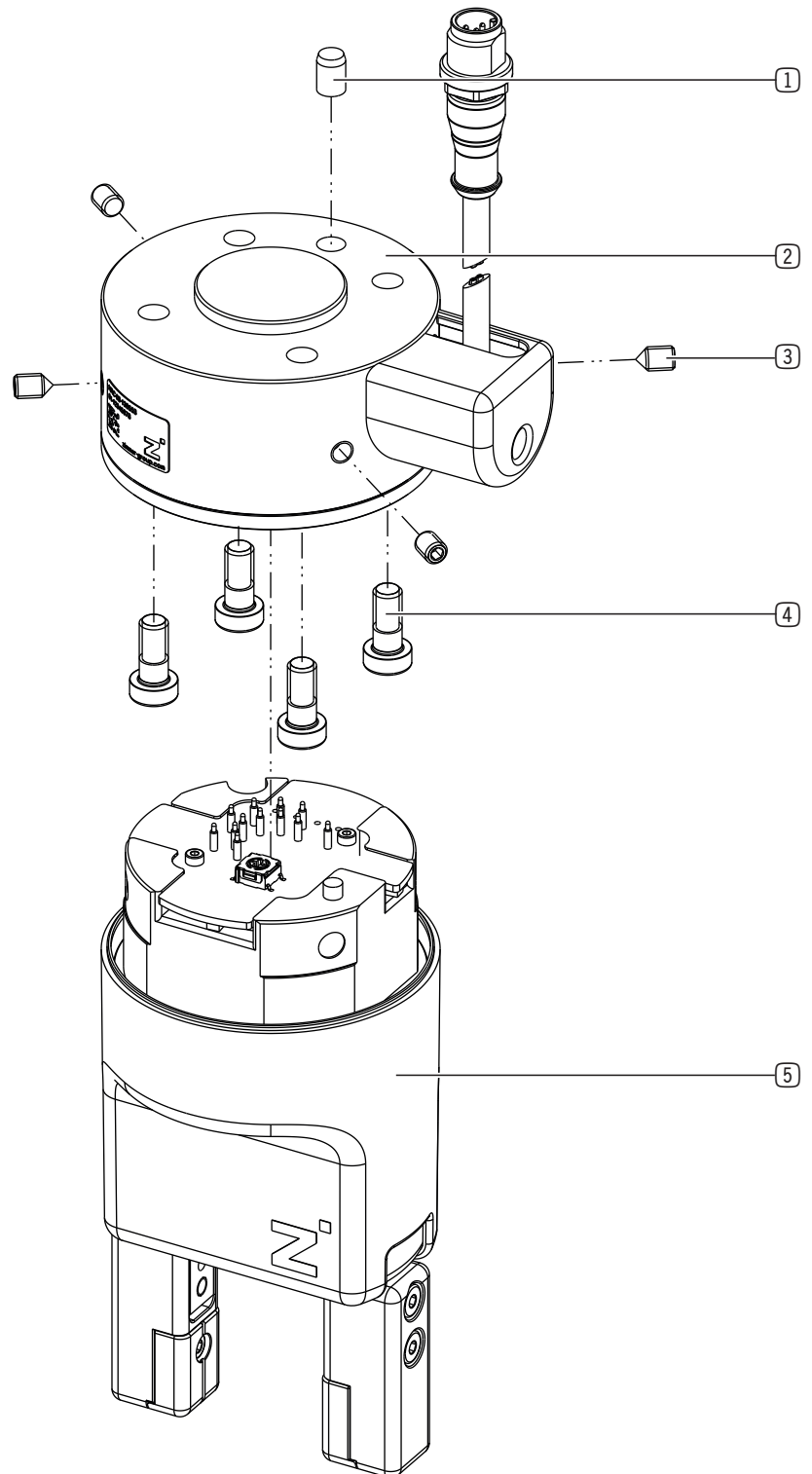

- ① Straight pins
- ② Connecting flange
- ③ Set Screw
- ④ Mounting screw
- ⑤ Case

### 10.2 Safe shutoff for products with IO-Link

#### INFORMATION



For safe shutoff for products with IO-Link, two contactors with one auxiliary contact each are switched in series. Here, the auxiliary contacts monitor the status of the contactors. If one contactor does not switch, the second contactor ensures safety. The malfunction can still be detected with the contacts.

#### INFORMATION



Without an externally fed voltage supply, the motor of the product cannot carry out an active movement and thus cannot carry out a hazardous movement.

There is no galvanic separation between the two voltage supplies (signal and power). There is a low-voltage connection via the GND connection.

Because of the self-locking mechanism, the product remains in the last approached position, even if no voltage is supplied.

The following figure shows the example of a circuit through which the IO-Link master cannot conduct the actuator current of the product.

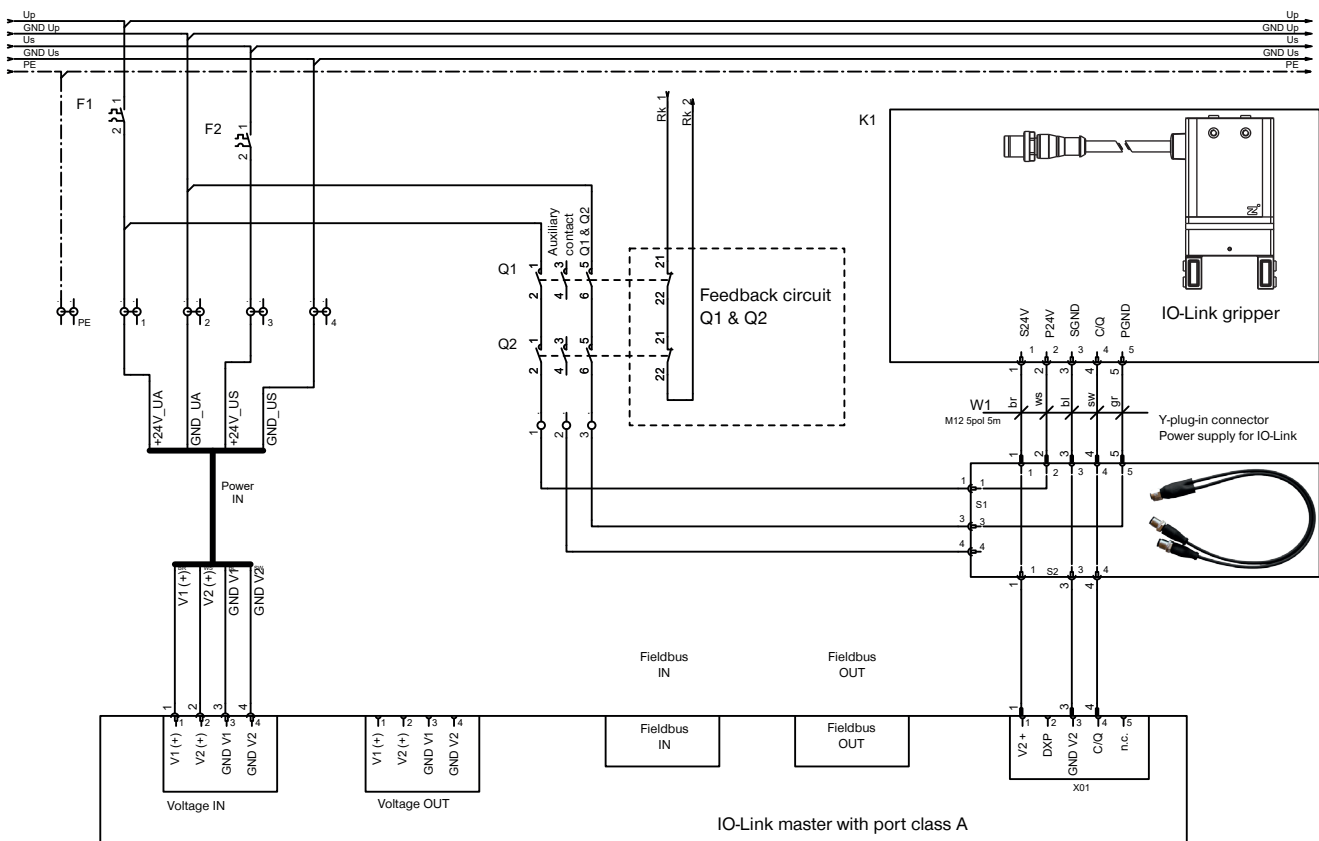

### 10.3 Installing the energy supply

#### CAUTION



**Risk of injury and material damage in case of non-compliance**

Incorrect pin assignment can lead to malfunction or destruction of the product.

- ▶ Be absolutely certain to ensure correct pin assignment.

#### NOTICE



**Material damage and malfunction in case of non-compliance**

The cable mounted on the product can be subjected to a torsional angle of +50°.

- ▶ Do not route the cable so that it is strained.
- ▶ You must meet the minimum bending radius of 10x the outer diameter.
- ▶ Secure free-hanging cables to prevent excessive motion loads or pinching.
- ▶ The contacts of the energy supply must be dry, clean and undamaged at all times.

- ▶ Connect the power supply cable to the control system of the product.

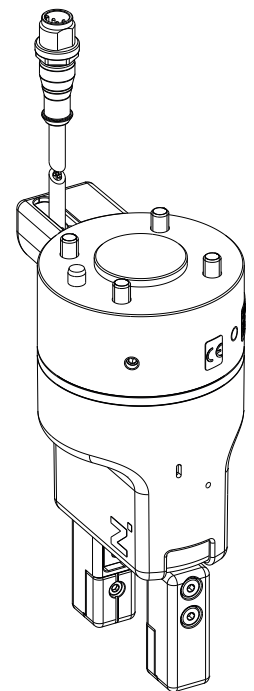

#### 10.3.1 HRC-03-138553 pin assignment

#### INFORMATION



- ▶ Note the deviation from IO-Link Port Class B: There is no galvanic separation between the actuator and sensor voltage in the product.

An optional B12 Y-plug-in connector allows electrical isolation from the perspective of the IO-Link master.

Pin	Color	Function	Explanation	Plug, M12
1	Brown	24 V DC sensor	24 V DC supply voltage for IO-Link communication	
2	White	PWR actuator	24 V DC supply voltage for actuator	
3	Blue	GND sensor	0 V DC supply voltage for IO-Link communication	
4	Black	C/Q	IO-Link communication	
5	Gray	GND actuator	0 V DC supply voltage for actuator	

- ▶ Connect the product to the IO-Link master.
- ▶ Switch on the voltage supply.
- ▶ Configure the IO-Link master (see the chapter "Commissioning").

### 10.3.2 Pin assignment of the Y plug-in connector

- ① Socket
- ② Plug 1
- ③ Plug 2

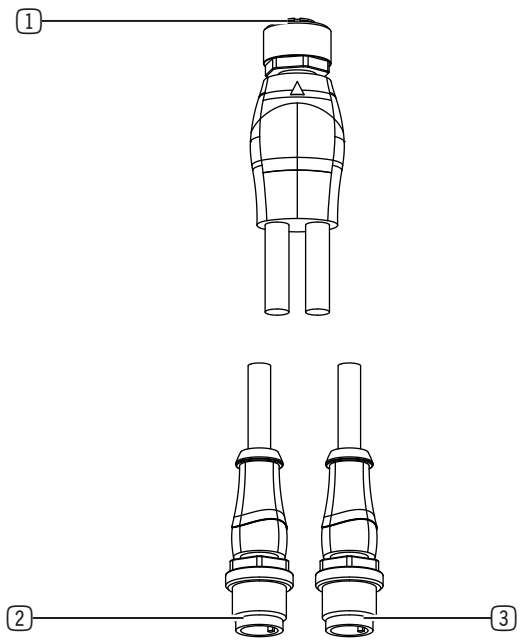

Pin	Color	Function	Explanation	Socket, M12
1	Brown	24 V DC sensor	24 V DC supply voltage for IO-Link communication	
2	White	PWR actuator	24 V DC supply voltage for actuator	
3	Blue	GND sensor	0 V DC supply voltage for IO-Link communication	
4	Black	C/Q	IO-Link communication	
5	Gray	GND actuator	0 V DC supply voltage for actuator	

Pin	Color	Function	Explanation	Plug 1, M12
1	Brown	PWR actuator	24 V DC supply voltage for actuator	
3	Blue	GND actuator	0 V DC supply voltage for actuator	
4	Black	-	-	

Pin	Color	Function	Explanation	Plug 2, M12
1	Brown	24 V DC sensor	24 V DC supply voltage for IO-Link communication	
3	Blue	GND sensor	0 V DC supply voltage for IO-Link communication	
4	Black	C/Q	IO-Link communication	

## 10.4 Static charge

### NOTICE



#### Material damage from static charge

Electrostatic voltages can occur if the product is mounted on insulating surfaces and no effective dissipation of static charges is possible.

- ▶ Please note that ESD-sensitive parts can be damaged if they come into contact with the product.
- ▶ Ground the product for applications that require high EMC resistance.

## 10.5 Heat dissipation

### NOTICE



#### Material damage from overheating of the product

If the product is operated under a very high ambient temperature or with fast clock cycles on an ongoing basis, this can reduce its service life.

- ▶ If the product is exposed to high ambient temperatures, always install it on heat-conducting materials.
- ▶ Reduce the load with increasing temperature.

## 10.6 Installing accessories

### NOTICE



#### Non-compliance may result in material damage.

- ▶ Before installing an accessory, make sure it is suitable for use with the selected variant.
- ▶ You can find information on our website.
- ▶ Please contact Customer Service if you have any questions.

## 11 Commissioning

### WARNING



#### Suspended loads can cause injury

Falling loads can cause severe injuries.

- ▶ Always keep an adequate safety distance from suspended loads.

### CAUTION



#### Reduction of the gripping force can cause injury and material damage

When flexible components are gripped, the gripping force of the product is reduced.

Reduced gripping force can cause injuries or material damage because the components can no longer be securely gripped and transported.

- ▶ Always keep an adequate safety distance from suspended loads.

### NOTICE



#### Malfunction in case of non-compliance

- ▶ Note the correct setting of the gripping force and the selection of the gripper finger length to prevent the gripper jaws from tensioning.

### NOTICE



#### Exclusion of liability regarding unauthorized use

This product may only be used for the proper use described in this documentation.

In particular, the following actions are prohibited:

- Tampering with the product or software
- Bypassing or disabling security mechanisms
- Unauthorized access to the product or interfaces
- ▶ Please note that the manufacturer assumes no liability for any resulting damage.
- ▶ Please note that warranty and support claims will be void in the event of misuse.

### 11.1 Process data

There is an option to control the product only with the process data that is transmitted in each cycle.

Process data output	Data type
ControlWord	UINT16
DeviceMode	UINT8
WorkpieceNo	UINT8
Reserve	UINT8
PositionTolerance	UINT8
GripForce	UINT8
DriveVelocity	UINT8
BasePosition	UINT16
Reserve	UINT16
TeachPosition	UINT16
WorkPosition	UINT16

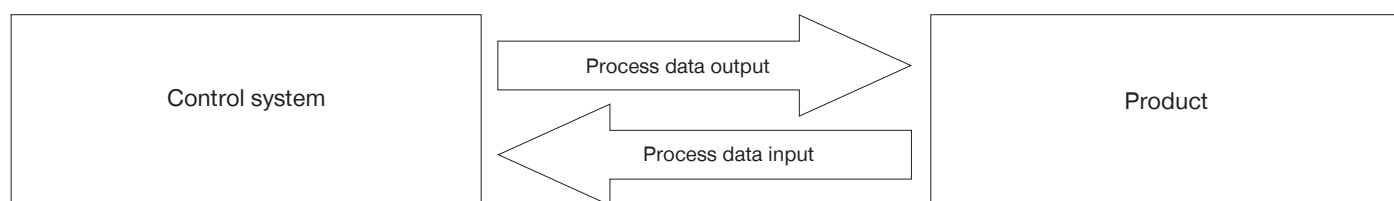

Process data input	Data type
StatusWord	UINT16
Diagnosis	UINT16
ActualPosition	UINT16

## 11.2 IODD Import

### INFORMATION



The product is controlled via IO-Link by means of the cyclical process data as well as the acyclic service data with a cycle time of 5 ms.

- ▶ You must check the process data.

- ▶ Import the IODD (device description) into the control system.
  - ▶ Go to our website.
  - ▶ Select the desired product.
  - ▶ Download the corresponding .zip file via the Downloads section under IODD.

As soon as the hardware configuration is complete and the IO-Link connection to the product is established, data will be displayed in the process input data.

Some control systems demand a byte swap to bring this process data into a logical sequence.

- ▶ Look at bit 6 (GripperPLCActive) in the StatusWord to determine whether a byte swap is necessary.
  - ▶ Determine whether bit 6 is active in the first or second byte of the StatusWord.
    - ⇒ Bit 6 is active in the first byte: The bytes already have the correct sequence.
      - ▶ Continue with the commissioning.
    - ⇒ Bit 6 is active in the second byte:
      - ▶ Apply a byte swap (see the section "StatusWord").

## 11.3 Data transmission via handshake

The transfer of process data to the product takes place with what is referred to as a handshake. All process data described in the following sections must be transferred with the handshake.

- ▶ Send the ControlWord = 0x0001 to the product.
  - ⇒ The data transfer has been started.
- ▶ Check the response of the product by using StatusWord.12 (DataTransferOK) = TRUE.
  - ⇒ The product is ready to operate.
- ▶ Send the ControlWord = 0x0000 to stop the data transfer.
  - ⇒ The data transfer is complete when the product sends back StatusWord.12 = FALSE.

### INFORMATION



- ▶ For examples, refer to the "Quickstart Basic Parameters" section.

## 11.4 Parameters

### 11.4.1 ControlWord

#### NOTICE



#### Malfunction in case of non-compliance

For ControlWord, only one single bit or the value 0 may be set at a time.

► Only use the values listed in the following table.

Parameter	Decimal value	Hexadecimal value
DataTransfer	1	0x0001
WritePDU	2	0x0002
ResetDirectionFlag	4	0x0004
Teach	8	0x0008
MoveToBase	256	0x0100
MoveToWork	512	0x0200
JogToWork +	1024	0x0400
JogToBase -	2048	0x0800
ErrorReset	32768	0x8000

<b>Data type</b>	UINT16
<b>Permission</b>	Write
<b>Transfer</b>	Cyclical
<b>Value range</b>	0 - 65535

	Bit 15	Bit 14	Bit 13	Bit 12	Bit 11	Bit 10	Bit 9	Bit 8
Byte 1	ErrorReset	-	-	-	JogToBase	JogToWork	MoveToWork	MoveToBase
	Bit 7	Bit 6	Bit 5	Bit 4	Bit 3	Bit 2	Bit 1	Bit 0
Byte 2	-	-	-	-	Teach	ResetDirectionFlag	WritePDU	DataTransfer

**Bit 0: DataTransfer**

Setting this bit causes the product to acquire the data transmitted in the process data ("WorkpieceNo" = 0) or the data stored in the workpiece data ("WorkpieceNo" = 1 to 32) as the active data set.

Setting this bit tells the product that the direction flag needs to be reset. This function is available starting from Application Firmware Version SWA000170\_A00 (see chapter "Table of acyclic data (ISDU)" Index 0x0017).

**Bit 1: WritePDU**

Setting this bit tells the product that the current process data should be written to the selected tool recipe.

**Bit 2: ResetDirectionFlag**

Setting this bit tells the product that the direction flag needs to be reset. This makes a repeated movement to a position possible. This is logical during a switchover of workpiece recipes.

**NOTICE****Material damage from overheating of the product**

- ▶ Please note that the product can be damaged from overheating due to repeated, prompt movement to the end stop or with a gripped workpiece.

**Bit 3: Teach**

Setting this bit tells the product that the current position should be saved as the TeachPosition in the selected WorkpieceNo. This only works if there is no "0" that is transmitted in the workpiece number.

**Bit 8: MoveToBase**

Setting this bit tells the product to move toward the BasePosition.

**Bit 9: MoveToWork**

Setting this bit tells the product to move toward the WorkPosition.

**Bit 10: JogToWork**

Setting this bit in the ControlWord puts the product in jog mode and the jaws move toward the WorkPosition. Resetting this bit stops the jaws.

**Bit 11: JogToBase**

Setting this bit in the ControlWord puts the product in jog mode and slowly moves the jaws toward the BasePosition. Resetting this bit stops the jaws.

**Bit 15: ErrorReset**

This bit can be used to acknowledge all errors that can be reset (see the section "Error diagnosis").

### 11.4.2 DeviceMode

#### INFORMATION



DeviceMode is used to select one of the following travel modes: universal operation, outside gripping or inside gripping. Zimmer Group GmbH recommends DeviceMode 63, 73 and 103.

Input	Mode	Description
63	Outside gripping with subsequent current feed	Like Mode 60, but with an activated subsequent current feed for a time of 500 ms when the direction of movement is Work. To achieve the best gripping results, the gripped workpiece must be transported further during the subsequent current feed.
73	Inside gripping with subsequent current feed	Like Mode 70, but with an activated subsequent current feed for a time of 500 ms when the direction of movement is Base. To achieve the best gripping results, the gripped workpiece must be transported further during the subsequent current feed.
103	Universal operation with subsequent current feed	Like Mode 100, but with an activated subsequent current feed for a time of 500 ms in both directions. To achieve the best gripping results, the gripped workpiece must be transported further during the subsequent current feed.
11	Jog mode	Product is in jog mode and moves slowly in the selected direction as long as the respective bit is active in the ControlWord.
50	Positioning mode	Product moves in the PositionProfile. The movement speed is configured using the DriveVelocity parameter.
60	Outside gripping	Inward with the desired gripping force, outward with the desired speed.
70	Inside gripping	Outward with the desired gripping force, inward with the desired speed.
100	Universal mode	Inside and outside gripping Both movements at the same speed depending on the desired gripping force.

<b>Data type</b>	UINT8
<b>Permission</b>	Write
<b>Transfer</b>	Cyclical
<b>Value range</b>	11, 50, 60, 63, 70, 73, 100, 103

### 11.4.2.1 PositionProfile

This mode can be used for positioning the gripper jaw or for form-fit gripping.

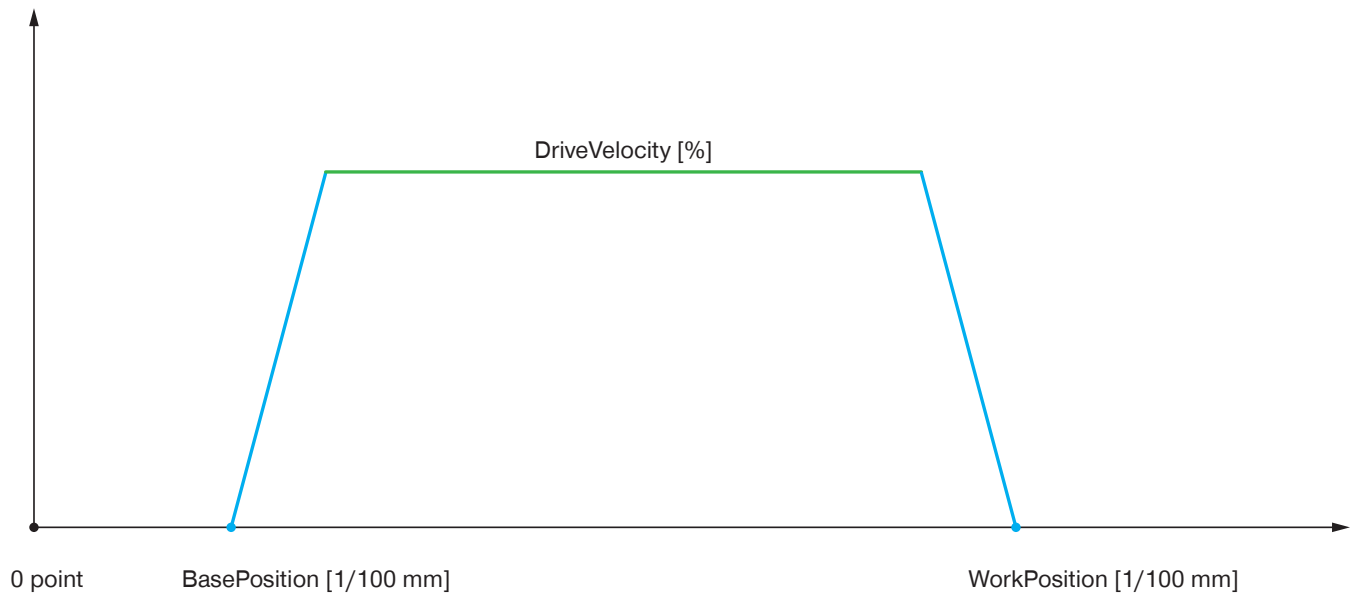

Parameter	Description
BasePosition	Gripper jaws open
WorkPosition	Gripper jaws closed
GripForce	Not used
TeachPosition	Not used
PositionTolerance	Not used
DriveVelocity	Movement speed

The movement speed is configured using the DriveVelocity parameter.

The TeachPosition does not have any significance in this mode, because the BasePosition or WorkPosition is always approached precisely.

If the jaws encounter an obstacle in this mode, they stop and the product issues an error message.

The jaws can be moved from the obstacle to the starting position again if the command is switched in the ControlWord.

No defined gripping forces can be generated in this mode. As a result, friction-locked gripping is not permitted in this mode.

### 11.4.2.2 ForceProfile

This mode can be used for frictional fit gripping.

The gripping force is built up by the movement speed of the jaws and the motor current. When a workpiece is clamped, an automatic locking mechanism is triggered, which keeps the workpiece in place when de-energized.

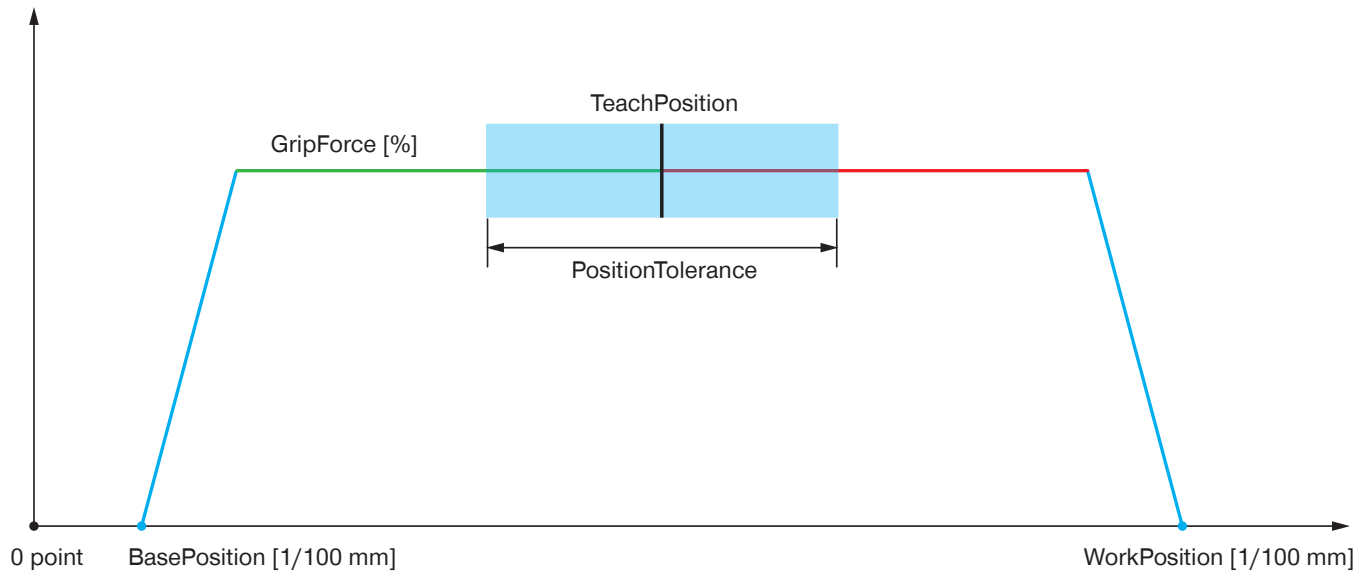

Parameter	Description
BasePosition	Gripper jaws open
WorkPosition	Gripper jaws closed
GripForce	Desired gripping force
TeachPosition	Expected position of the workpiece
PositionTolerance	Permitted tolerance for the workpiece
DriveVelocity	Opening speed

Since gripping should occur in one direction only, the positioning mode is used automatically in the opposite direction.

When opening, the product switches into positioning mode automatically.

The direction in which the workpiece is gripped is determined by the travel mode:

- Outside gripping: Mode group 60
- Inside gripping: Mode group 70

## INFORMATION



In order to position precisely at the set WorkPosition and BasePosition, the braking process begins shortly before the desired position is reached.

As a result, it is possible that the full gripping force may not be achieved. Braking before the target position can be deactivated by setting the parameters.

DeviceMode	Parameters for disabling the braking ramp
60, 63 (outside gripping)	WorkPosition = max. position (see the section "WorkPosition")
70, 73 (inside gripping)	BasePosition = 0

### Mode Group 60: Typically used for outside gripping

DeviceMode	Action	ControlWord
63	Move toward the WorkPosition until this position or the workpiece is reached.	0x0200
63	Move toward the BasePosition to open the jaws.	0x0100

### Mode Group 70: Typically used for inside gripping

DeviceMode	Action	ControlWord
73	Move toward the BasePosition until this position or the workpiece is reached.	0x0100
73	Move toward the WorkPosition to open the jaws.	0x0200

### 11.4.3 WorkpieceNo

The workpiece number is used for selecting the previously stored workpiece data, as well as for selecting the WorkpieceNo data record in which the current process data is stored.

WorkpieceNo enables individual workpieces to be taught in to the product very quickly if the recipes are not managed on the control system.

With a value > 0 and data acquisition via a handshake, the corresponding workpiece recipe is loaded in the product.

#### INFORMATION



► You can find example codes in the sections “Quickstart Basic Parameters” and “Recipe Examples”.

<b>Data type</b>	UINT8
<b>Permission</b>	Write
<b>Transfer</b>	Cyclical
<b>Value range</b>	0 - 32

### 11.4.4 PositionTolerance

The TeachPosition notifies the product of the expected position of the workpiece.

The PositionTolerance defines the tolerance range around the TeachPosition.

They are used to configure the position tolerance with a resolution of 0.01 mm.

Thus, the value range of 0 to 255 can be used to set a maximum tolerance of 2.55 mm in both directions.

#### INFORMATION



Example:

For TeachPosition 1200 (12 mm), PositionTolerance 150 lets you set a tolerance of 1.5 mm in both directions. This means that the TeachPosition range starts at 10.5 mm and goes up to 13.5 mm.

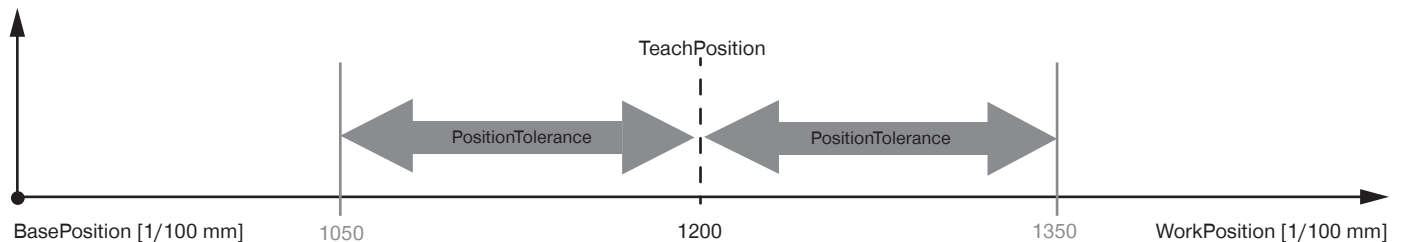

<b>Data type</b>	UINT8
<b>Permission</b>	Write
<b>Transfer</b>	Cyclical
<b>Value range</b>	0 to 255

### 11.4.5 GripForce

The product can use various gripping forces and gripping speeds to achieve an optimized flow of the gripping process. Since the product generates gripping force from the gripping speed and the amperage, the gripping force setting also conversely influences the gripping speed and amperage. The gripping force can be adjusted in four stages.

Name	GripForce	
Data type	UINT8	
Permission	Write	
Transfer	Cyclical	
Value range	1	Level 1
	2	Level 2
	3	Level 3
	4	Level 4

### 11.4.6 DriveVelocity

The product can work at various movement speeds for an optimized process sequence.

This parameter determines the movement speed of the gripper jaws in both directions in PositionProfile.

In the other modes, this parameter determines the movement speed from the workpiece.

Name	DriveVelocity	
Data type	UINT8	
Permission	Write	
Transfer	Cyclical	
Value range	1	Level 1
	2	Level 2
	3	Level 3
	4	Level 4

#### 11.4.7 BasePosition

The BasePosition defines the target position in the MoveToBase direction. It must always be less than the WorkPosition. The product verifies this and, if necessary, displays an error message.

If the current position of the jaws is within the tolerance range in the vicinity of the BasePosition, bit 8 is set in the StatusWord.

<b>Data type</b>	UINT16
<b>Permission</b>	Write
<b>Transfer</b>	Cyclical
<b>Value range</b>	0 to WorkPosition

#### 11.4.8 TeachPosition

The TeachPosition notifies the product of the expected position of the workpiece.

The StatusWord notifies the control system of whether the correct workpiece has been gripped.

If the jaws are within the tolerance range in the vicinity of the TeachPosition, bit 9 is set in the StatusWord.

► Use the following values:

Product	TeachPosition
HRC-03-138553	0 to max. 2000

<b>Data type</b>	UINT16
<b>Permission</b>	Write
<b>Transfer</b>	Cyclical
<b>Value range</b>	0 to max. jaw stroke of the product

#### 11.4.9 WorkPosition

The WorkPosition defines the maximum travel path of the product and has to be greater than the BasePosition.

<b>Data type</b>	UINT16
<b>Permission</b>	Write
<b>Transfer</b>	Cyclical
<b>Value range</b>	BasePosition to max. jaw stroke of the product

### 11.4.10 StatusWord

	Bit 15	Bit 14	Bit 13	Bit 12	Bit 11	Bit 10	Bit 9	Bit 8
<b>Byte 1</b>	Error	ControlWord 0x0200	ControlWord 0x0100	DataTransferOK	UndefinedPo- sition	WorkPosition	TeachPosition	BasePosition
	Bit 7	Bit 6	Bit 5	Bit 4	Bit 3	Bit 2	Bit 1	Bit 0
<b>Byte 0</b>	-	Gripper- PLCActive	JogWork- Active +	JogBase- Active -	Movement- Complete	InMotion	MotorON	HomingPo- sition OK
<b>Data type</b>	UINT16							
<b>Permission</b>	Read							
<b>Transfer</b>	Cyclical							
<b>Value range</b>	0 - 65535							

#### Bit 0: HomingPosition OK

The product is calibrated at the factory and does not have to be referenced by the customer.

#### Bit 1: MotorON

The motor of the product switches on automatically when there is a move command. The customer cannot switch it on/off manually.

#### Bit 2: InMotion

This bit is active during the run.

#### Bit 3: MovementComplete

This bit is active after the movement is complete.

#### Bit 4: JogBaseActive -

This bit provides feedback during travel in the direction of the BasePosition.

#### Bit 5: JogWorkActive +

This bit provides feedback during travel in the in the direction of the WorkPosition.

#### Bit 6: GripperPLCActive

Active as soon as the product has booted up after the cold boot. This bit can be used to verify a "byte swap."

#### Bit 8: BasePosition

Active if the product is set to BasePosition.

#### Bit 9: TeachPosition

Active if the product is set to TeachPosition.

#### Bit 10: WorkPosition

Active if the product is set to WorkPosition.

**Bit 11: UndefinedPosition**

Active if the product is not set to TeachPosition, WorkPosition or BasePosition.

**Bit 12: DataTransferOK**

This bit is used for data transmission with the handshake. Active as soon as the product has taken over the data with the parameter ControlWord 1 (decimal).

**Bit 13: ControlWord 0x0100**

This bit is a direction flag. Active if the last motion task was carried out toward BasePosition.

**Bit 14: ControlWord 0x0200**

This bit is a direction flag. Active if the last motion task was carried out toward WorkPosition.

**Bit 15: Error**

Active if the product has an active error. The error message can be determined using Diagnosis.

### 11.4.10.1 Acknowledging an error

If the product has a fault, the error bit is set in the StatusWord.

- ▶ Acknowledge the error by sending ControlWord 0x8000.

#### NOTICE



#### Malfunction in case of non-compliance

Not all errors can be reset. For some errors, such as *maximum permissible temperature exceeded*, the error message is not reset after acknowledgment.

- ▶ In this case, wait until correct values are sent to the product.

#### INFORMATION



- ▶ Use the StatusWord to check whether a workpiece has been gripped correctly.
- ▶ The TeachPosition tolerance can be adjusted in another process parameter.
- ▶ Observe the tolerances and fluctuations around the exact value of the actual position during programming the position query.

### 11.4.11 Diagnosis

The value returned in Diagnosis corresponds to the error code (see "Error Diagnosis" section).

<b>Data type</b>	UINT16
<b>Permission</b>	Read
<b>Transfer</b>	Cyclical
<b>Value range</b>	0 - 65535

### 11.4.12 ActualPosition

ActualPosition is the current position of the gripper jaws.

The value is specified with a resolution of 0.01 mm.

The values can move between the BasePosition (minimum values) and the WorkPosition (maximum values).

Product	BasePosition	WorkPosition	TeachPosition	Accuracy [mm]
HRC-03-138553	0	2000	0 to max. 2000	± 0.05

<b>Data type</b>	UINT16
<b>Permission</b>	Read
<b>Transfer</b>	Cyclical
<b>Value range</b>	0 to max. jaw stroke of the product

#### INFORMATION



- ▶ Use the StatusWord to check whether a workpiece has been gripped correctly.
  - The position measurement resolution is 0.01 mm.
  - The accuracy of the position measurement depends on the installation size.
- ▶ Be aware of fluctuations around the exact value if you use ActualPosition to detect the workpiece.

### 11.5 Cold start

For proper function, Zimmer Group GmbH recommends that the actuator and sensor voltage be supplied with power separately.

- ▶ Switch on the sensor voltage.
- ▶ Switch on the actuator voltage as soon as the product communicates with the control system.

Depending on the application, simultaneous activation of both voltages is possible.

#### INFORMATION



If the sensor voltage is disconnected, the C/Q signal (IO-Link) must be disconnected as well.

### 11.6 Minimum travel path

The product requires a certain minimum travel path to move to the desired position.

Design size	Minimum travel path per gripper jaw [mm]
HRC-03-138553	1

### 11.7 Minimum positioning path

The product requires a certain minimum positioning path to reach the desired gripping force.

#### INFORMATION



- ▶ You can find the information in the technical data sheet on our website.
- ▶ Please contact Customer Service if you have any questions.

### 11.8 Easy Startup

Describes the process from switching on the product to the initial movement.

- ▶ Connect the product according to its assignment diagram.
- ⇒ The product reports the process parameters StatusWord, Diagnosis and ActualPosition immediately after the internal controller is booted up.
- ⇒ As soon as the PLCActive bit is registered in the StatusWord, the communication process can start.
- ▶ Transmit the process parameters to move the gripper jaws.
  - DeviceMode
  - GripForce
  - DriveVelocity
  - BasePosition
  - WorkPosition
- ▶ Transmit the parameters to the product with a handshake.

#### INFORMATION



- ▶ For more information, refer to the section “Handshake data transfer method”.
- ▶ You can find example codes in the sections “Quickstart Basic Parameters” and “Recipe Examples”.

## 11.9 Quickstart Basic Parameters

In the following example, you see the first initialization of the product, the activation of the motor and the transmission of the process parameters.

```
// Initialization of the product
// Motor switch-on
// Initial move command
// = EasyStartUp Example

IF bStart = TRUE THEN
    iStep          := 10;
END_IF

CASE iStep OF

10:
    IF StatusWord.6 THEN // Query for PLCActive bit in the StatusWord
        DeviceMode      := 103; // Command to select the universal mode
        WorkpieceNo     := 0; // 0 = current process parameters are being used
        PositionTolerance := 50;
        GripForce       := 4; // Gripping force setting
        BasePosition    := 100;
        TeachPosition   := 1200;
        WorkPosition    := 1200;
        ControlWord     := 1; // Data transfer to the product
        iStep           := 20; // Jump to the next step
    END_IF

20:
    IF StatusWord.12 THEN // Query for DataTransferOK bit in the StatusWord
        ControlWord     := 0; // Reset of the initialization
        iStep           := 30; // Jump to the next step
    END_IF

30:
    IF NOT StatusWord.12 THEN
        ControlWord     := 512; // Handshake is completed,
                               // Product moves to WorkPosition (0x0200 or 512(decimal) = MoveToWork)
        iStep           := 100;
    END_IF

100:
    ; // Continue with the program

END_CASE
```

### 11.10 Starting jaw movement

- ▶ Send ControlWord 0x0200 so that the jaws move toward the WorkPosition.
  - ⇒ The jaws move toward the inside.
- ▶ Send ControlWord 0x0100 so that the jaws move toward the BasePosition.
  - ⇒ The jaws move toward the outside.
    - The motion task must be pending for as long as it takes until the desired position is reached.
    - The current motion task is canceled as a result of a new handshake.
- ⇒ When the jaws reach the corresponding position, this is displayed in the StatusWord as follows:
  - The jaws are in the BasePosition: StatusWord.8 = TRUE
  - The jaws are in the TeachPosition: StatusWord.9 = TRUE
  - The jaws are in the WorkPosition: StatusWord.10 = TRUE

### 11.11 Starting the jaw movement from any position (EasyMode)

#### INFORMATION



In application firmware versions prior to SWA000226\_B00, error 0x0307 is returned for the *MoveToBase* and *MoveToWork* move commands under the following conditions:

- *MoveToBase*:  $BasePosition > ActualPosition$
- *MoveToWork*:  $WorkPosition < ActualPosition$

► Please note that a hard-coded range of 0.75 mm is defined for the *WorkPosition* and *BasePosition* parameters.

The *MoveToBase* and *MoveToWork* move commands can be executed regardless of the current jaw position.

The move commands can be modified with ISDU *EasyMode*. There are two options available.

- EasyMode Standard
- EasyMode Restricted

► Please refer to section “Table of acyclic data (ISDU).”

EasyMode	ActualPosition	Move command	Jaw movement
Standard	BasePosition	MoveToBase	yes
	WorkPosition	MoveToWork	yes
Restricted	BasePosition	MoveToBase	no
	WorkPosition	MoveToWork	no

#### 11.11.1 EasyMode Standard

If the product is in the *BasePosition* or *WorkPosition*, it will be repositioned even if another identical move command is issued.

► Please note that the corresponding direction flag must be set to Low.

##### MoveToBase command

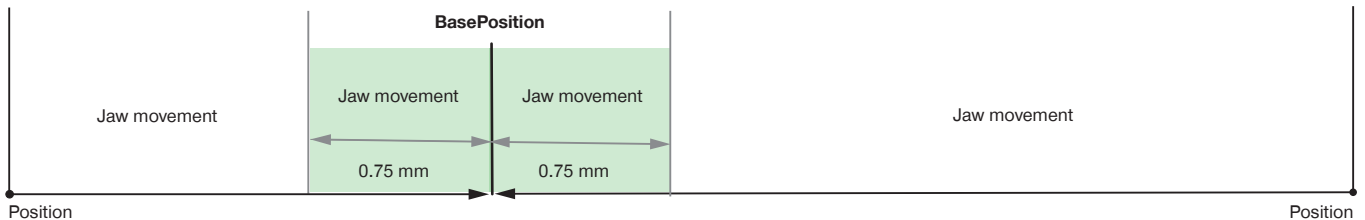

##### MoveToWork command

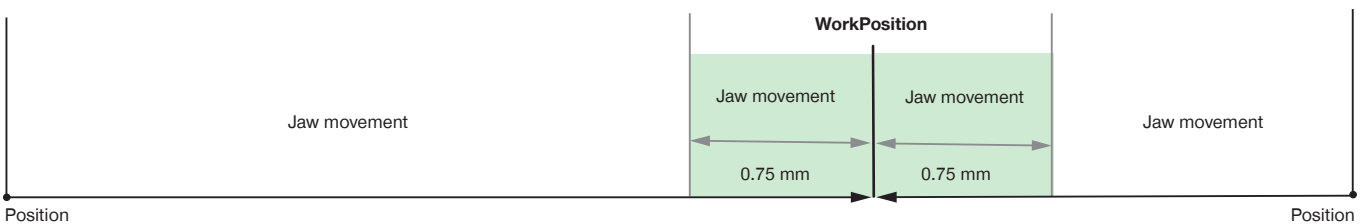

### 11.11.2 EasyMode Restricted

If the product is in the BasePosition or WorkPosition, it will not be repositioned in response to another identical move command.

► Please note that the corresponding direction flag must be set to Low.

#### MoveToBase command

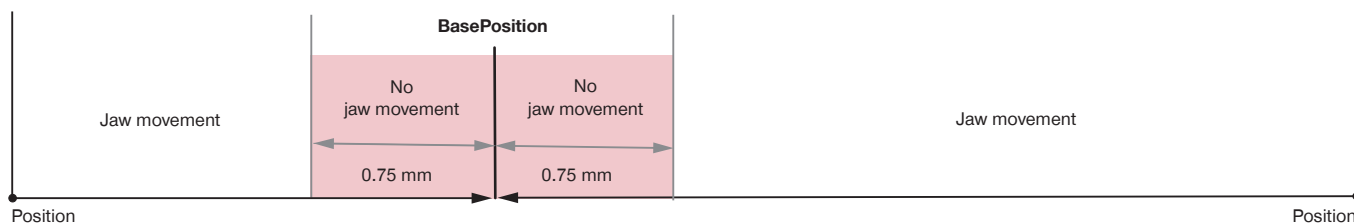

#### MoveToWork command

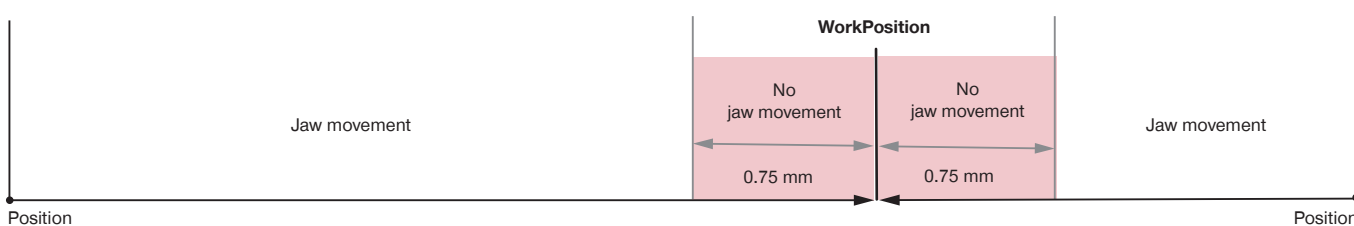

### 11.12 Workpiece loss detection

The workpiece loss detection function is available for DeviceModes 63, 73 and 103.

It is activated if the permissible jaw displacement is exceeded during the gripping process.

#### 11.12.1 Current profile during the gripping process

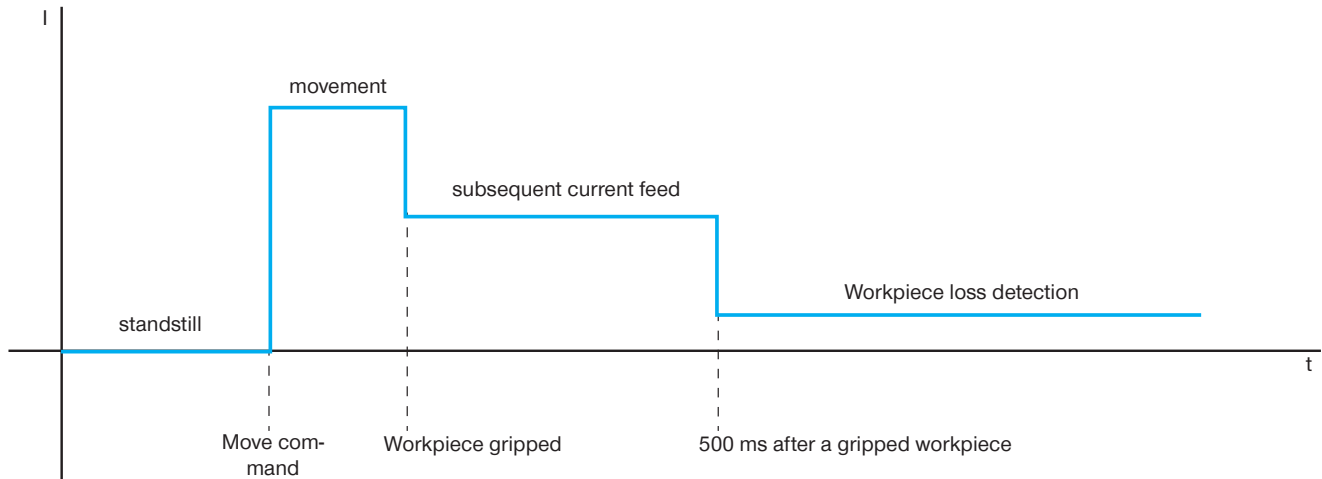

#### INFORMATION



If a workpiece is lost, the product moves to the end position and displays an error message.

► For more information, please refer to the "Error diagnosis" section.

#### 11.12.2 Modifying workpiece loss detection

#### INFORMATION



The error message can be disabled using the ISDU *WorkPieceLossError*, available starting with application firmware version SWA000226\_B00.

► Please refer to section "Table of acyclic data (ISDU)."

#### INFORMATION



The default values for workpiece loss detection can be modified using the ISDU *WorkPieceLossTolerance*, available starting with application firmware version SWA000226\_B00.

Design size	Jaw offset Default value [0.01 mm]
HRC-03-138553	40

### 11.13 Repeated movements in the same direction

The StatusWord includes two static flag bits, each of which is set in alternation when the product moves in one direction. This prevents uncontrolled movements of the product in case of faulty data transmission.

Depending on the location of the positions, it is possible that the product may move multiple times in the same direction. For this purpose, the direction flags must be reset.

► Send the ControlWord = 0x0004 to delete the direction flags.

⇒ The direction flags are reset when the product answers with StatusWord.13 AND 14 = FALSE.

Program example for repeated movements in the same direction:

```
// Multiple movement in one direction in Structured Text (ST)
// The product is not capable of accepting multiple move commands in the same direction.
// That is why the direction flag has to be reset in the StatusWord.
// In this example, all process parameters are already correctly transferred.
// The previous move command toward the WorkPosition could not be executed
// because the product is being blocked by a workpiece.
// After the workpiece is removed, the direction flag is reset
// and the move command is restarted.

IF bReset = TRUE THEN
    iStep          := 10;
END_IF

CASE iStep OF

10:
    IF Diagnose = 16#307 THEN          // Move command could not be executed.
        iStep          := 20;        // Jump to the error step
                                        // to reset the direction flag
    END_IF

20:
    ControlWord      := 4;           // Reset the direction flags
                                        // (ResetDirectionFlag bit = TRUE in the ControlWord)
    iStep            := 30;        // Jump to the next step

30:
    IF NOT StatusWord.13 AND NOT      // Query whether both direction flags
    StatusWord.14 THEN                // (Bit ControlWord 0x0100 AND
                                        // ControlWord 0x0200 = FALSE in ControlWord)
        ControlWord      := 512;    // Moves back toward WorkPosition
        iStep            := 100;
    END_IF;

100:
    ;                                // Continue with the program

END_CASE
```

## 11.14 Recipe examples

### INFORMATION



The process parameters can be saved in the internal workpiece recipe and reloaded.

Workpiece recipes can be managed at both the product and control levels.

- ▶ Manage the process parameters at the control level.
  - Same amount of time, since the workpiece recipe is transferred via a handshake.
  - The product can be easily replaced.

#### 11.14.1 Save recipe

The following example code shows how process parameters can be stored in the internal workpiece recipe.

```
// Store tool workpiece recipes in Structured Text (ST)
```

```
IF bStart = TRUE THEN
    iStep          := 10;
END_IF

CASE iStep OF

10:
    DeviceMode      := 103;    // Assignment of desired process parameters
    WorkpieceNo     := 3;      // Recipe is to be stored as the third workpiece recipe
    PositionTolerance := 50;
    BasePosition    := 100;
    WorkPosition    := 2000;
    GripForce       := 1;
    TeachPosition   := 500;
    iStep           := 20;    // Jump to the next step

20:
    ControlWord     := 1;      // Begins with the handshake
    iStep           := 30;    // Jump to the next step

30:
    IF StatusWord.12 THEN      // Queries the bit DataTransferOK=TRUE from StatusWord,
                                // Response of the product to transferred data
        ControlWord := 0;      // Reset the ControlWord
        iStep       := 40;    // Jump to the next step
    END_IF;

40:
    IF NOT StatusWord.12 THEN  // Query for completion of the data transfer,
                                // DataTransferOK = FALSE
        ControlWord := 2;      // Handshake is completed,
                                // storage starts here via the WritePDU bit in the ControlWord
        iStep       := 50;    // Jump to the next step
    END_IF;

50:
    IF StatusWord.12 THEN      // Queries the DataTransferOK = TRUE bit from StatusWord
        ControlWord := 0;      // Reset the ControlWord
        iStep       := 60;    // Jump to the next step
    END_IF;

60:
    IF NOT StatusWord.12 THEN  // Query for completion of the data transfer,
                                // DataTransferOK = FALSE
        iStep       := 0;      // Storage is completed
    END_IF;

END_CASE
```

### 11.14.2 Loading a recipe

The following example code shows how process parameters can be loaded to the internal workpiece recipe.

```
// Load workpiece recipes in Structured Text (ST)
IF bLoad = TRUE THEN
    iStep          := 10;
END_IF

CASE iStep OF

10:
    WorkpieceNo    := 3;    // Load third workpiece recipe
    iStep          := 20;    // Jump to the next step

20:
    ControlWord    := 1;    // Begins with the handshake
    iStep          := 30;    // Jump to the next step

30:
    IF StatusWord.12 THEN          // Queries the bit DataTransferOK=TRUE from StatusWord,
                                    // Response of the product to transferred data
        ControlWord    := 0;    // Reset the ControlWord
        iStep          := 40;    // Jump to the next step
    END_IF;

40:
    IF NOT StatusWord.12 THEN      // Query for completion of the data transfer,
                                    // DataTransferOK = FALSE
        iStep          := 0;    //Handshake is completed,
                                    // Parameters from the third recipe have been taken over into the current process parameters.
    END_IF;
END_CASE
```

## 12 Operation

### 12.1 Setting the gripping force

For products with IO-Link, you can adjust the gripping force by using the control system.

### 12.2 Emergency release

#### CAUTION



#### Risk of injury due to uncontrolled movements

Risk of injury in the event of uncontrolled movement of the product when the power supply is connected.

- ▶ Switch off the power supply to the machine before carrying out any work.
- ▶ Secure the power supply against being switched on unintentionally.
- ▶ Check the machine for any residual energy that may be present.

#### CAUTION



#### Risk of injury in case of non-compliance

- ▶ Disconnect the actuator voltage before pressing the emergency release.

#### INFORMATION



In the event of a power failure, the jaws remain in their positions and the gripping force of the product stays constant.

The product has an emergency release that can be unlocked mechanically and allows the jaws to be opened.

- ▶ Please contact Customer Service if you have any questions.

- ▶ Secure the workpieces to prevent them from falling.
- ▶ Actuate the emergency release with a corresponding Allen key.
  - ▶ Use a wrench size of 1.5 mm.

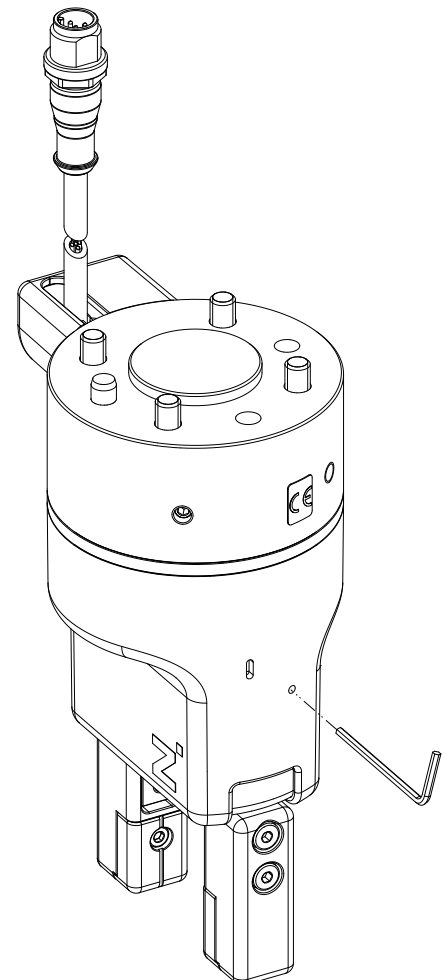

## 13 Gripping force charts

### INFORMATION















- ▶ You can find the information in the technical data sheet on our website.
- ▶ Please contact Customer Service if you have any questions.

## 14 Error diagnosis

Error code	Error	Possible cause	Measure
0x0000	Device is ready for operation.	-	-
0x0002	Position measuring system not referenced.	<ul style="list-style-type: none"> <li>Product does not have any reference position.</li> </ul>	<ul style="list-style-type: none"> <li>▶ Please contact Customer Service.</li> </ul>
0x0003	Device is booted up.	<ul style="list-style-type: none"> <li>The device is in the start sequence.</li> </ul>	<ul style="list-style-type: none"> <li>▶ Wait until the start sequence is complete.</li> </ul>
0x0100	Actuator power supply is not present or is too low	<ul style="list-style-type: none"> <li>Actuator power supply is not connected</li> <li>Actuator power supply is not sufficient</li> <li>Cable break</li> </ul>	<ul style="list-style-type: none"> <li>▶ Check the actuator power supply.</li> </ul>
0x0101	Temperature above maximum permitted temperature.	<ul style="list-style-type: none"> <li>Ambient temperature is too high</li> <li>Overload of the product</li> </ul>	<ul style="list-style-type: none"> <li>▶ Provide sufficient ventilation/cooling/heat dissipation.</li> <li>▶ Make sure that the product moves freely.</li> </ul>
0x0102	Temperature is below minimum permitted temperature.	<ul style="list-style-type: none"> <li>Ambient temperature is too low</li> </ul>	<ul style="list-style-type: none"> <li>▶ Provide an adequate operating temperature.</li> </ul>
0x0103	Temperature of the power level is too high	<ul style="list-style-type: none"> <li>Surrounding temperature is too high</li> <li>Overload of the product</li> <li>Internal defect</li> </ul>	<ul style="list-style-type: none"> <li>▶ Ensure improved cooling of the product.</li> <li>▶ Make sure that the product moves freely.</li> <li>▶ Increase the break time between the gripping movements.</li> <li>▶ Select a suitable DeviceMode.</li> </ul>
0x010B	Workpiece lost	<ul style="list-style-type: none"> <li>Gripping force is not sufficient</li> <li>Workpiece was not gripped correctly</li> <li>Gripper finger geometry does not match the gripped workpiece</li> <li>Workpiece is too heavy</li> </ul>	<ul style="list-style-type: none"> <li>▶ Check the required gripping force.</li> <li>▶ Check the gripper finger geometry.</li> <li>▶ Reset the error by sending another move command back.</li> </ul>
0x0300	ControlWord is not plausible.	<ul style="list-style-type: none"> <li>Multiple bits were set in the ControlWord.</li> </ul>	<ul style="list-style-type: none"> <li>▶ In the ControlWord, check that only one bit is set.</li> </ul>
0x0301	Position implausible	<ul style="list-style-type: none"> <li>Transmitted TeachPosition is not plausible.</li> </ul>	<ul style="list-style-type: none"> <li>▶ Check the transmitted process data.</li> </ul>
0x0302	GripForce is not plausible.	<ul style="list-style-type: none"> <li>Transmitted GripForce is not plausible.</li> </ul>	<ul style="list-style-type: none"> <li>▶ Check the transmitted process data.</li> </ul>
0x0303	DriveVelocity not plausible	<ul style="list-style-type: none"> <li>Transmitted DriveVelocity is not plausible.</li> </ul>	<ul style="list-style-type: none"> <li>▶ Check the transmitted process data.</li> </ul>
0x0304	PositionTolerance is not plausible.	<ul style="list-style-type: none"> <li>Transmitted PositionTolerance is not plausible.</li> </ul>	<ul style="list-style-type: none"> <li>▶ Check the transmitted process data.</li> </ul>
0x0306	DeviceMode is not plausible.	<ul style="list-style-type: none"> <li>Transmitted DeviceMode is not plausible.</li> </ul>	<ul style="list-style-type: none"> <li>▶ Check the transmitted process data.</li> </ul>

Error code	Error	Possible cause	Measure
0x0307	Motion task cannot be executed.	<ul style="list-style-type: none"> <li>Multiple motion tasks in the same direction.</li> <li>Move command transmitted despite existing error.</li> </ul>	<ul style="list-style-type: none"> <li>▶ Reset the direction flag. <ul style="list-style-type: none"> <li>• through move command in the opposite direction</li> <li>• through error reset</li> <li>• through reset direction flag</li> </ul> </li> <li>▶ Send the move command again.</li> </ul>
0x0308	WorkpieceNo cannot be selected.	<ul style="list-style-type: none"> <li>Transmitted workpiece number is outside the permitted range.</li> </ul>	<ul style="list-style-type: none"> <li>▶ Check the transmitted process data.</li> <li>▶ Apply the process data via a handshake.</li> </ul>
0x0309	TeachPosition was changed.	<ul style="list-style-type: none"> <li>Modified process data were not taken over.</li> </ul>	<ul style="list-style-type: none"> <li>▶ Apply the process data via a handshake.</li> </ul>
0x030A	BasePosition was changed.	<ul style="list-style-type: none"> <li>Modified process data were not taken over.</li> </ul>	<ul style="list-style-type: none"> <li>▶ Apply the process data via a handshake.</li> </ul>
0x030B	ShiftPosition was changed.	<ul style="list-style-type: none"> <li>Modified process data were not taken over.</li> </ul>	<ul style="list-style-type: none"> <li>▶ Apply the process data via a handshake.</li> </ul>
0x030C	WorkPosition was changed.	<ul style="list-style-type: none"> <li>Modified process data were not taken over.</li> </ul>	<ul style="list-style-type: none"> <li>▶ Apply the process data via a handshake.</li> </ul>
0x030D	GripForce was changed.	<ul style="list-style-type: none"> <li>Modified process data were not taken over.</li> </ul>	<ul style="list-style-type: none"> <li>▶ Apply the process data via a handshake.</li> </ul>
0x030E	DriveVelocity was changed.	<ul style="list-style-type: none"> <li>Modified process data were not taken over.</li> </ul>	<ul style="list-style-type: none"> <li>▶ Apply the process data via a handshake.</li> </ul>
0x030F	PositionTolerance wurde verändert.	<ul style="list-style-type: none"> <li>Modified process data were not taken over.</li> </ul>	<ul style="list-style-type: none"> <li>▶ Apply the process data via a handshake.</li> </ul>
0x0310	DeviceMode was changed.	<ul style="list-style-type: none"> <li>Modified process data were not taken over.</li> </ul>	<ul style="list-style-type: none"> <li>▶ Apply the process data via a handshake.</li> </ul>
0x0311	WorkpieceNo was changed.	<ul style="list-style-type: none"> <li>Modified process data were not taken over.</li> </ul>	<ul style="list-style-type: none"> <li>▶ Apply the process data via a handshake.</li> </ul>
0x0312	Initial state after gripper restart	<ul style="list-style-type: none"> <li>Modified process data were not taken over.</li> </ul>	<ul style="list-style-type: none"> <li>▶ Apply the process data via a handshake.</li> </ul>
0x0314	BasePosition $\geq$ WorkPosition	<ul style="list-style-type: none"> <li>Transmitted BasePosition <math>\geq</math> transmitted WorkPosition</li> </ul>	<ul style="list-style-type: none"> <li>▶ Check the transmitted process data.</li> </ul>
0x0400	Difficulty of movement	<ul style="list-style-type: none"> <li>Gripper jaws are blocked.</li> <li>Guide moves with difficulty.</li> </ul>	<ul style="list-style-type: none"> <li>▶ Make sure that the product moves freely.</li> <li>▶ Acknowledge the error.</li> </ul>
0x040B	Error	<ul style="list-style-type: none"> <li>Error</li> </ul>	<ul style="list-style-type: none"> <li>▶ Please contact Customer Service.</li> </ul>
0x0406	System error	<ul style="list-style-type: none"> <li>Internal system error</li> </ul>	<ul style="list-style-type: none"> <li>▶ Please contact Customer Service.</li> </ul>
0x0411	No production parameters present on the product.	<ul style="list-style-type: none"> <li>Error</li> </ul>	<ul style="list-style-type: none"> <li>▶ Please contact Customer Service.</li> </ul>

### 14.1 Status of the LED display

Status	Meaning	Measure
<ul style="list-style-type: none"> <li> LED lights up continuously green.</li> <li> LED does not light up.</li> </ul>	<ul style="list-style-type: none"> <li>• No error</li> </ul>	-
<ul style="list-style-type: none"> <li> LED lights up continuously green.</li> <li> LED flashes red.</li> </ul>	<ul style="list-style-type: none"> <li>• No connection to the IO-Link device</li> </ul>	<ul style="list-style-type: none"> <li>▶ For more information, refer to the “Error diagnosis” section.</li> </ul>
<ul style="list-style-type: none"> <li> LED does not light up.</li> <li> LED lights up continuously red.</li> </ul>	<ul style="list-style-type: none"> <li>• Actuator voltage not OK</li> </ul>	-
<ul style="list-style-type: none"> <li> LED does not light up.</li> <li> LED flashes red.</li> </ul>	<ul style="list-style-type: none"> <li>• Process data are invalid.</li> <li>• Error</li> </ul>	-
<ul style="list-style-type: none"> <li> The green and red LEDs flash simultaneously.</li> <li> LED flashes red.</li> </ul>	<ul style="list-style-type: none"> <li>• Product does not have any reference position.</li> </ul>	<ul style="list-style-type: none"> <li>▶ A reference run must be performed.</li> </ul>
<ul style="list-style-type: none"> <li> The green and red LEDs flash alternately.</li> <li> LED flashes red.</li> </ul>	<ul style="list-style-type: none"> <li>• A reference run is being performed.</li> </ul>	-

## 15 Table with acyclic data (ISDU)

### INFORMATION



IO-Link distinguishes between cyclical data (PDU) and acyclic data (ISDU).

Access to acyclic data is not arranged very conveniently for all control system and IO-Link master combinations. For this reason, the product can be used without acyclic data. This makes it as easy as possible to control the product.

► Please contact Customer Service if you have any questions.

### INFORMATION



► Note that the acyclic data with the following parameters correspond to the reflection of the process data:

- StatusWord, Diagnosis, ControlWord, ActualPosition, TeachPosition, WorkpieceNo, DeviceMode, PositionTolerance, GripForce, DriveVelocity, BasePosition, ShiftPosition, WorkPosition

Index	Name	Data type	Access rights	Values
0x0017 (23)	Firmware version	STRING	Read	-
	<b>Description</b> Firmware version <ul style="list-style-type: none"> <li>• Example: SWA000170_A00                             <ul style="list-style-type: none"> <li>• Type: SWA000170</li> <li>• Version: A00</li> </ul> </li> </ul>			
0x0040 (64)	StatusWord	UINT16	Read	0 - 65535
	<b>Description</b> Read out the StatusWord			
0x0041 (65)	Diagnosis	UINT16	Read	0 - 65535
	<b>Description</b> Read out of the diagnostic code			
0x0042 (66)	Cycle counter	UINT32	Read	0 to 4294967295
	<b>Description</b> Read out of the total number of cycles			
0x0043 (67)	Temperature	UINT16	Read	0 to 100 °C
	<b>Description</b> Current temperature			
0x0044 (68)	ControlWord	UINT16	Read	0 - 65535
	<b>Description</b> Read out of the ControlWord			
0x0045 (69)	Error code	STRING	Read	1 to 32
	<b>Description</b> Read out of the current error state			
0x0046 (70)	Error counter	UINT32	Read	0 to 4294967295
	<b>Description</b> Read out of the number of errors since the restart			
0x0100 (256)	ActualPosition	UINT16	Read	0 to max. jaw stroke of the product [0,01 mm]
	<b>Description</b> Read out the current position of the gripper jaws			
0x0101 (257)	TeachPosition	UINT16	Read	0 to max. jaw stroke of the product [0,01 mm]
	<b>Description</b> Read out of the current transmitted TeachPosition			

Index	Name	Data type	Access rights	Values
0x0102 (258)	WorkpieceNo	UINT8	Read	0 - 32
	<b>Description</b> Read out of the transmitted workpiece number			
0x0103 (259)	DeviceMode	UINT8	Read	1-103
	<b>Description</b> Read out of the transmitted travel mode			
0x0104 (260)	PositionTolerance	UINT8	Read	0 to 255
	<b>Description</b> Read out of the transmitted tolerance of the TeachPosition			
0x0105 (261)	GripForce	UINT8	Read	1 to 130 %
	<b>Description</b> Read out of the transmitted gripping force			
0x0107 (263)	DriveVelocity	UINT8	Read	1 to 100 %
	<b>Description</b> Read out of the transmitted movement speed			
0x0108 (264)	BasePosition	UINT16	Read	0 to max. jaw stroke of the product [0,01 mm]
	<b>Description</b> Read out of the transmitted outer jaw position			
0x0109 (265)	ShiftPosition	UINT16	Read	0 to max. jaw stroke of the product [0,01 mm]
	<b>Description</b> Read out of the transmitted toggle position			
0x010A (266)	WorkPosition	UINT16	Read	0 to max. jaw stroke of the product [0,01 mm]
	<b>Description</b> Read out of the transmitted inner jaw position			
0x0114 (276) Subindex 1 to 4	Tolerance window WorkPosition/BasePosition	UINT16	Read/write	0 - 65535
	<b>Description</b> Setting the BasePosition and WorkPosition tolerance window <ul style="list-style-type: none"> <li>• Subindex 0: Read/write</li> <li>• Subindex 1: from BasePosition to the outside</li> <li>• Subindex 2: from BasePosition to the inside</li> <li>• Subindex 3: from WorkPosition to the inside</li> <li>• Subindex 4: from WorkPosition to the outside</li> </ul> Resetting all changes to factory settings using an IO-Link factory reset			
0x0125 (293)	EasyMode	UINT8_t	Read/write	0 to 1
	<b>Description</b> Activation of EasyMode Standard <ul style="list-style-type: none"> <li>• Value = 0</li> </ul> Activation of EasyMode Restricted <ul style="list-style-type: none"> <li>• Value = 1</li> </ul>			
Index	Name	Data type	Access rights	Values
0x022F (559)	Holding current	UINT16	Read/write	0 to 1000
	<b>Description</b> Amperage [%] for current after-supply scaled to the maximum permitted current.			

Index	Name	Data type	Access rights	Values
0x0230 (560)	Holding time	UINT16	Read/write	0 to 1000
	<b>Description</b>			
Time duration [ms] for current after-supply				
0x0232 (562)	Emergency Mode	UINT16	Read/write	0 to 1
	<b>Description</b>			
	Deactivation of message 0x0400 by ISDU: <ul style="list-style-type: none"> <li>• Index = 562 (decimal)</li> <li>• Subindex = 0</li> <li>• Value = 0</li> </ul>	Activation of message 0x0400 by ISDU: <ul style="list-style-type: none"> <li>• Index = 562 (decimal)</li> <li>• Subindex = 0</li> <li>• Value = 1</li> </ul>		
0x0233 (563)	WorkpieceLossTolerance	UINT16_t	Read/write	0 to 500
	<b>Description</b>			
Permissible jaw displacement [0.01 mm]				
0x0234 (564)	WorkpieceLossError	UINT8_t	Read/write	0 to 1
	<b>Description</b>			
	Activation of message 0x010B by ISDU: <ul style="list-style-type: none"> <li>• Value = 1</li> </ul>	Deactivation of message 0x010B by ISDU: <ul style="list-style-type: none"> <li>• Value = 0</li> </ul>		
0x0235 (565)	UndervoltageFilter	UINT16_t	Read/write	0 – 250
	<b>Description</b>			
Delay time [ms] for error message 0x0100.				

## 16 Maintenance

### NOTICE



#### Material damage resulting from blowing out with compressed air

Blowing out the product with compressed air can cause malfunctions.

- ▶ Never purge the product with compressed air.

### NOTICE



#### Material damage caused by unsuitable cleaning materials

Seals, insulation, coatings and other surfaces may be damaged by solvent-based cleaning agents.

- ▶ Make sure that no liquids penetrate the product.
- ▶ Use chemically and biologically neutral cleaning agents.
- ▶ Use cleaning agents that are categorized as being nonhazardous to health.
- ▶ Use soft, lint-free cloths for cleaning the surface.

The use of the following cleaning agents is strictly prohibited:

- Acetone
- Cleaning solvent
- Nitrocellulose thinner/turpentine oil (solvents)

### NOTICE



#### Contamination of the environment due to escaping lubricants

Lubricants can escape through moving machine parts. This can lead to contamination of the machine, the workpiece and the environment.

- ▶ Remove leaking lubricant immediately and thoroughly.

Maintenance-free operation of the product is guaranteed for up to 10 million cycles.

- ▶ Note that the product could become damaged under the following circumstances:
    - Dirty environment
    - Improper use and use that does not comply with the performance data
    - Permissible temperature range not observed
  - ▶ Even though the product is maintenance-free as mentioned above, perform a regular visual inspection to check for any damage or contamination.
  - ▶ Have maintenance work that requires disassembly of the product performed by customer service only.
- ⇒ Dismantling and reassembling the product without authorization may result in complications, as special installation equipment is required in some cases. Zimmer Group GmbH accepts no liability for any resulting malfunctions or damage.

## 17 Decommissioning/disposal

### INFORMATION



When the product reaches the end of its operational phase, it can be completely disassembled and disposed of.

- ▶ Disconnect the product completely from the power supply.
- ▶ Dispose of the components properly according to the material groups.
- ▶ Comply with the locally applicable environmental and disposal regulations.

## 18 RoHS declaration

in terms of the EU Regulation 2011/65/EU

### Name and address of the manufacturer:

Zimmer Group GmbH

 Am Glockenloch 2  
77866 Rheinau, Germany

 +49 7844 9138 0

 [info@zimmer-group.com](mailto:info@zimmer-group.com)

 [www.zimmer-group.com](http://www.zimmer-group.com)

We hereby declare that the incomplete machine described below

**Product designation:** 2-jaw parallel gripper

**Type designation:** HRC-03

conforms to the requirements of the directive in its design and the version we put on the market.

Michael Hoch

Authorized representative for the  
compilation of relevant technical  
documents

Rheinau, Germany, 2022-01-06

(Place and date of issuance)

Martin Zimmer  
(Legally binding signature)  
Managing Partner

## 19 Declaration of Incorporation (Machinery Directive)

In terms of the EU Machinery Directive 2006/42/EC (Annex II 1 B)

### Name and address of the manufacturer:

**Zimmer Group GmbH**

📍 Am Glockenloch 2  
77866 Rheinau, Germany

☎ +49 7844 9138 0

✉ [info@zimmer-group.com](mailto:info@zimmer-group.com)

🌐 [www.zimmer-group.com](http://www.zimmer-group.com)

We hereby declare that the incomplete machine described below

**Product designation:** 2-jaw parallel gripper

**Type designation:** HRC-03

conforms to the requirements of the Machinery Directive, 2006/42/EC, Article 2g, Annex VII, b – Annex II, b, in its design and the version we put on the market.

We hereby confirm that all the relevant basic health and safety requirements for the product have been observed and implemented.

A full list of applied standards can be obtained from the manufacturer.

We also declare that the specific technical documents were produced in accordance with Annex VII Part B of this Directive. We undertake to provide the market supervisory bodies with electronic versions of special documents for the incomplete machine through our documentation department, should they have reason to request them.

**The incomplete machine may only be commissioned if it has been ascertained, if applicable, that the machine or system in which the incomplete machine is to be installed satisfies the requirements of Directive 2006/42/EC on Machinery and an EC Declaration of Conformity has been drawn up in accordance with Annex II 1 A.**

Kurt Ross

Authorized representative for the compilation of relevant technical documents

Rheinau, Germany, 2022-01-06

(Place and date of issuance)



Martin Zimmer  
(Legally binding signature)  
Managing Partner

## 20 Declaration of Incorporation

In terms of the EU Machinery Regulation 2023/1230, Annex V, Part B

### Name and address of the manufacturer:

**Zimmer Group GmbH**

📍 Am Glockenloch 2  
77866 Rheinau, Germany

☎ +49 7844 9138 0

✉ [info@zimmer-group.com](mailto:info@zimmer-group.com)

🌐 [www.zimmer-group.com](http://www.zimmer-group.com)

We hereby declare that the incomplete machine described below

**Product designation:** 2-jaw parallel gripper

**Type designation:** HRC-03

conforms to the requirements of the Regulation 2023/1230, Article 3.10, Annex III, Annex IV Part B, Annex V Part B, in its design and the version we put on the market.

A complete list of the standards applied and the essential safety and health protection requirements is available from the manufacturer.

**The incomplete machine may only be commissioned if it has been ascertained, if applicable, that the machine or system in which the incomplete machine is to be installed satisfies the requirements of the EU Machinery Regulation 2023/1230 and an EC Declaration of Conformity has been drawn up in accordance with Annex V, Part A.**

Kurt Ross

Authorized representative for the compilation of relevant technical documents

Rheinau, Germany, 2027-01-20

(Place and date of issuance)



Martin Zimmer  
(Legally binding signature)  
Managing Partner

## 21 Declaration of Conformity

As defined by the EC Directive 2014/30/EU on electromagnetic compatibility

### Name and address of the manufacturer:

Zimmer Group GmbH

Am Glockenloch 2

77866 Rheinau, Germany

+49 7844 9138 0

info@zimmer-group.com

www.zimmer-group.com

We hereby declare that the product described below

**Product designation:** 2-jaw parallel gripper

**Type designation:** HRC-03

conforms to the requirements of the 2006/42/EC directive in its design and the version we put on the market.

The following harmonized standards have been used:

DIN EN ISO 12100	Safety of machinery - General principles for design - Risk assessment and risk reduction
DIN EN 61000-6-3	EMC Generic standard, Emission standard for residential, commercial and light-industrial
DIN EN 61000-6-2	EMC Generic standard, Emission standard for industrial environments
DIN EN 61000-6-4	EMC Generic standard, Immunity for industrial environments

A full list of applied standards can be obtained from the manufacturer.

Kurt Ross

Authorized representative for the compilation of relevant technical documents

Rheinau, Germany, 2022-01-06

(Place and date of issuance)



Martin Zimmer  
(Legally binding signature)  
Managing Partner