

CLAMPING AND BRAKING ELEMENTS | HYDRAULIC

LBHS2505BS2 + PLBH25-4

▶ PRODUCT ADVANTAGES



- ▶ **broad range of products**
For all common profile rail guides
- ▶ **Energize to open (NC)**
through residual stress
- ▶ **the power pack**
0.5 million static clamping cycles
- ▶ **Safety element**
Safe braking in case of energy failure
- ▶ **Maximum flexibility**
Additional hydraulic connection from above

▶ TECHNICAL DETAILS



- ① **Profile rail guide**
 - Available for all common profile rail guides
- ② **Housing - functional component**
 - Generating clamping force by clamping material
 - Narrow and low design
- ③ **Eroding contour**
 - Used for opening the element under pressure
- ④ **Clamping jaws and brake shoes**
 - Pressed at the free surfaces of the profile rail guide
- ⑤ **Sealing plates**
 - for double-sided hydraulic line connection
- ⑥ **Scraper**
 - Optionally available with "A" article ending

▶ INFORMATION ON THE PRODUCTS

APPLICATION SCENARIOS

- ▶ **Precise positioning through maximum rigidity**
- ▶ **Clamping measurement applications**
- ▶ **Clamping and braking of heavy handling systems**
- ▶ **Braking in emergency OFF situations**
- ▶ **Clamping in case of pressure drop**

FURTHER INFORMATION

- ▶ **Spacer plate**
In addition, a spacer plate might have to be ordered as height compensation, depending on the height of the rail carriage (dimension D).

Track manufacturer	Rail type	Rail size	Carriage type
Bosch Rexroth	R18.. / RSA (roll)	25	R1821 (SNH)

TECHNICAL DRAWINGS

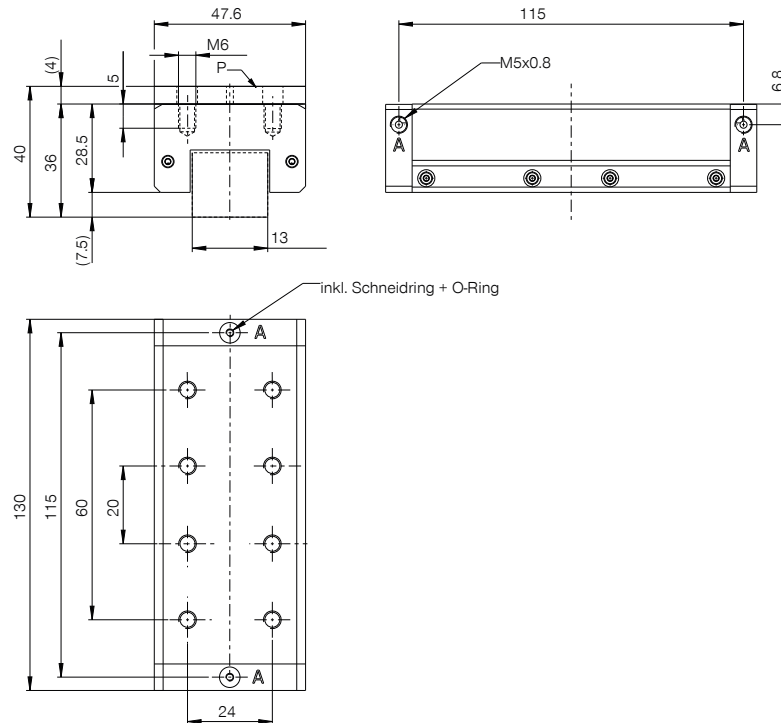

Ⓐ Connection opening (both sides possible, only one connection necessary)



TECHNICAL DATA

Order No.	LBHS2505BS2 + PLBH25-4
Operation	hydraulic
Holding force	2000 [N]
Theoretical holding force ($\mu=0,1$)	2,500 [N]
PLUS connection possible	No
Operating pressure	120 ... 130.0 [bar]
B10d value	500,000
Positioning accuracy +/-	0,02 [mm]
Opening time	0.02 [s]
Closing time	0.02 [s]
Operating temperature	-10 ... +70 [°C]
Weight	0.9 [kg]
Function	Clamping and braking
Condition	NC (Normally Closed) closed without pressure
Installation direction	from the front
Masking tape can be used	with masking tape

Schematic drawing. General tolerances according to DIN ISO 2768 T1-4/T2-H. Edges according to ISO 13715. Element has no guiding properties. Guidance must be external. The holding force is the maximum force that can be applied in the axial direction. Each clamping and braking element is tested in a 100% inspection before delivery for the specified holding forces on a hardened steel rail with a lightly oiled lubricating layer (ISO-VG 68). The use of other lubricants or rail coatings can influence the coefficient of friction. The operating instructions must be observed before commissioning. We reserve the right to make technical changes in the course of further development. The latest and further data can be found online and in the operating instructions at www.zimmer-group.com.