

# CLAMPING AND BRAKING ELEMENTS | HYDRAULIC KBH3501RS1A

## ▶ PRODUCT ADVANTAGES



- ▶ **broad range of products**  
For all common profile rail guides
- ▶ **Energize to close (NO)**  
Closing with pressure
- ▶ **extremely durable**  
Up to 10 million static clamping cycles

## ▶ TECHNICAL DETAILS



- ① **Profile rail guide**
  - Available for all common profile rail guides
- ② **Return spring**
  - Interlocked integration in the jaws
- ③ **Clamping jaws and brake shoes**
  - Pressed at the free surfaces of the profile rail guide
- ④ **Housing**
- ⑤ **Membran**
  - For pressurization
- ⑥ **Scraper**
  - Can also be ordered as an option

## ▶ INFORMATION ON THE PRODUCTS

### APPLICATION SCENARIOS

- ▶ **Machine table clamping of heavy cutting work centres**
- ▶ **Clamping and braking of heavy handling systems**
- ▶ **Braking**

### FURTHER INFORMATION

- ▶ **Spacer plate**  
In addition, a spacer plate might have to be ordered as height compensation, depending on the height of the rail carriage (dimension D).
- ▶ **Special variants on request, e.g.**  
With additional hydraulic connection (from above, from the front)
- ▶ **Also available for rail size 85/100/125**

Track manufacturer	Rail type	Rail size	Carriage type
THK	HRX	35	HRX..C

## ▶ TECHNICAL DRAWINGS

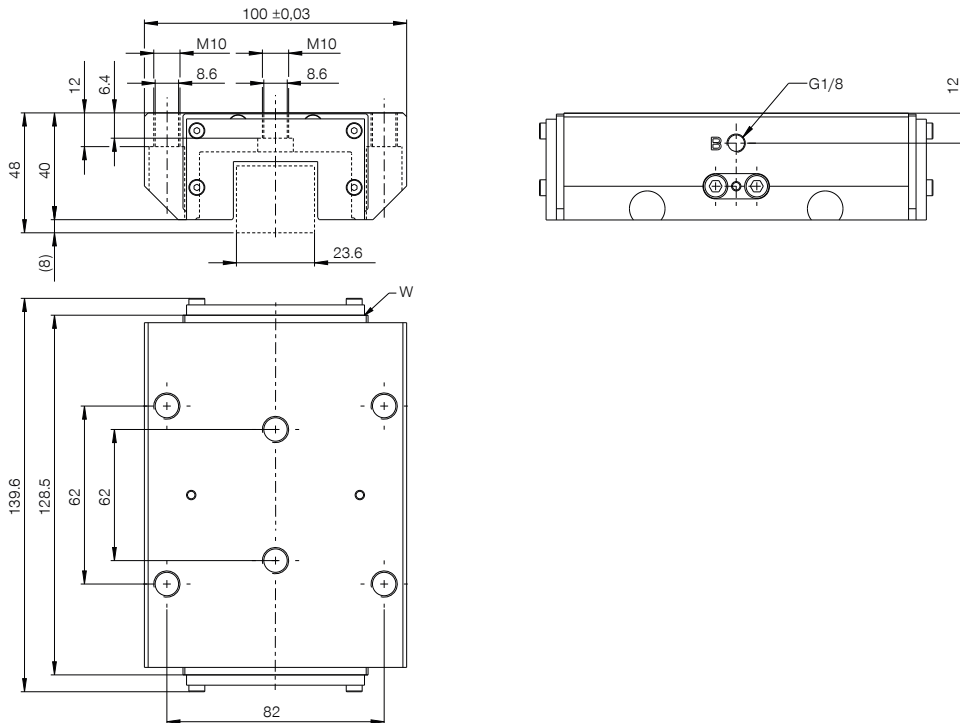

Ⓑ Connection closing (both sides possible, only one connection necessary)

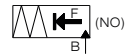

## ▶ TECHNICAL DATA

Order No.	KBH3501RS1A
Operation	hydraulic
Holding force	5700 [N]
PLUS connection possible	No
Operating pressure	5 ... 160 [bar]
Nominal operating pressure	150.0 [bar]
B10d value	10,000,000
Positioning accuracy +/-	0,02 [mm]
Opening time	0.06 [s]
Closing time	0.1 [s]
Operating temperature	-10 ... +70 [°C]
Weight	2.7 [kg]
Function	Clamping and braking
Condition	NO (Normally Open) open without pressure
Installation direction	from the front
Masking tape can be used	without masking tape
Wiper	yes

Schematic drawing. General tolerances in accordance with DIN ISO 2768 T1-f/T2-H. Edges in accordance with ISO 13715. Stop face can be used on both sides. Center fixing holes must be used. Element offers no guiding properties. Guidance must be external. The holding force is the maximum force that can be applied in the axial direction. Each clamping and braking element is tested in a 100% inspection before delivery for the specified holding forces on a hardened steel rail with a lightly oiled lubricating layer (ISO-VG 68). The use of other lubricants or rail coatings can influence the coefficient of friction. The operating instructions must be observed before commissioning. We reserve the right to make technical changes in the course of further development. The latest and further data can be found online and in the operating instructions at [www.zimmer-group.com](http://www.zimmer-group.com).